



Rural Lands

Development Control Plan

APPLIES TO LAND ZONED:

- **RU1 PRIMARY PRODUCTION**
- **RU2 RURAL LANDSCAPE**
- **E2 ENVIRONMENTAL CONSERVATION**
- **E3 ENVIRONMENTAL MANAGEMENT**
- **SP3 TOURIST**

SCHEDULE OF AMENDMENTS

Adopted 28 October 2010, Effective 3 March 2021.

Amended as follows:

Amendment #	Nature of Amendment	Adopted	Effective
1	Various, as adopted by Council	14 September 2011	5 October 2011
2	Various, as adopted by Council	14 December 2011	8 February 2012
3	Various, as adopted by Council	11 July 2012	1 August 2012
4	Various, as adopted by Council	22 August 2012	5 September 2012
5	Corrected to insert Temporary Development A3.8 which had been inadvertently omitted.		22 June 2013
6	Corrected to remove reference to Adaptable Housing which was inserted in error.		18 October 2013
7	Corrected to reflect amendment to Clause 5.4(9) of WLEP2010 with regard to maximum area of Secondary Dwelling.		21 January 2014
8	Corrected to amend typing error with regard to maximum height of hedges.		23 April 2014
9	Amendments with regard to Function Centres	25 March 2015	22 April 2015
10	Various, as adopted by Council	8 November 2017	29 November 2017
11	Amendment relating to Equine	12 December 2018	9 January 2019

Effective 1 January 2021

RURAL LANDS DEVELOPMENT CONTROL PLAN

	Facilities		
12	Berrima Landscape Conservation Area	11 September 2019	18 September 2019
13	Signage	28 October 2020	3 March 2021



CONTENTS

PART A	MANAGING OUR RURAL LANDS	1
Section 1	Introduction	1
A1.1	Citation	1
A1.2	Date of Commencement	1
A1.3	Land To Which This Plan Applies	1
A1.4	Associated Planning Instruments and Council Endorsed Specifications	1
A1.5	Maps contained in this Plan	2
A1.6	Structure of this Plan	2
Section 2	Classification and Distribution of Rural Lands	3
A2.1	Introduction.....	3
A2.2	The Natural Bushland Ecological Setting	3
A2.3	Rural Ecological Setting	4
A2.4	Agricultural Land Classification	6
A2.5	Zone Distribution & Objectives	14
A2.6	The Value of Rural Land	19
A2.7	Subdivision of Rural Land	19
Section 3	Ecologically Sustainable Development.....	21
A3.1	Introduction.....	21
A3.2	Development in Sydney’s Drinking Water Catchments	22
A3.3	Protection of Watercourses and Riparian Lands	24
A3.4	Statement of Environmental Effects	25
A3.5	Site Analysis.....	26
Figure A3.1	27
Figure A3.2	27
A3.6	Cut and Fill.....	28



A3.7	Siting of Rural Buildings.....	28
A3.8	Temporary Development	29
Section 4	Vegetation Management.....	30
A4.1	Introduction.....	30
A4.2	The Importance of Biodiversity	30
A4.3	Vegetative Barrier Planting, Hedging & Row Plantings	32
A4.4	Weed Management.....	35
A4.5	Landform and Vegetation Modification	36
A4.6	Earth Works.....	37
A4.7	Protection of Trees, Bushland and Vegetation during Construction.....	37
A4.8	Environmental Remediation.....	38
A4.9	Arborist’s Report	39
A4.10	Roadside Reserves.....	39
A4.11	Preservation of Trees and Other Vegetation	40
Section 5	Water Management	52
A5.1	Introduction.....	52
A5.2	Development within Sydney’s Drinking Water Catchments	54
A5.3	Water Sensitive Design.....	58
A5.4	On-site Waste Water Disposal (OSWD) systems	67
A5.5	Stormwater Management Plans	67
A5.6	Erosion and Sediment Control Plans	67
A5.7	Protection of Watercourses, Water bodies and Riparian Lands	68
A5.8	Water Storage Facilities	74
A5.9	Flood Liable Land.....	75
Section 6	Additional Controls.....	99
A6.1	Introduction.....	99
A6.2	Bushfire Prone Land	99



A6.3	Contaminated or Potentially Contaminated Land.....	100
A6.4	Demolition of Existing Structures	103
A6.5	Regional Wildlife Corridors.....	104
A6.6	Development in the vicinity of a National Park or Nature Reserve	104
A6.7	Sites Requiring Geotechnical Reports	105
A6.8	Minimisation of External Impacts - Noise	105
A6.9	Minimisation of External Impacts - Odour	106
A6.10	Minimisation of External Impacts - Outdoor Lighting	107
A6.11	Construction of Private Roads.....	109
A6.12	Property Entrances and Front Fencing.....	109
A6.13	Roadside Stalls.....	111
A6.14	Truck Parking.....	112
A6.15	Airstrips and Helipads.....	113
A6.16	Wind Turbines	115
A6.17	Signage	119
A6.18	Council Approval for Signage	120
A6.19	Signage for which no Development Application is required	120
Section 7	Development Near Rail Corridors & Busy Roads	129
A7.1	Development Adjacent to a Rail Corridor	129
Section 8	Heritage and Landscape Conservation	131
A8.1	Introduction.....	131
A8.2	General Objectives	132
A8.3	Alterations to and Restoration of Heritage Items and Draft Heritage Items	133
A8.4	Development in the vicinity of Heritage Items.....	135
A8.5	Alterations and New Development in Heritage Conservation Areas	136
A8.6	Berrima Landscape Conservation Area	136
A8.7	Burradoo Landscape Conservation Area	168



A8.8	Joadja Conservation Area	168
A8.9	Throsby Park Conservation Area	169
Section 9	Construction Standards & Procedures	171
A9.1	Introduction.....	171
A9.2	Surveys and Reports.....	171
A9.3	Building near or over Council Mains and Easements	172
A9.4	Building over two or more Allotments	173
A9.5	Subfloor Areas of Buildings	173
A9.6	Exhaust Fans.....	174
A9.7	Water Storage in Non-reticulated Areas	174
A9.8	Stormwater Disposal	174
A9.9	Structures Over Public Areas.....	175
A9.10	Site Access Standards During Construction.....	176
A9.11	Footpath Protection During Construction and Hoardings.....	177
A9.12	Waste Management and Disposal	177
A9.13	Inspections under a Section 68 approval	179
A9.14	Civil Design & Certification	179
A9.15	Re-sited Buildings	180
A9.16	Property Address – Street and Rural numbering	180
A9.17	Unformed Roads	181
Section 10	Telecommunications and Radiocommunications Infrastructure	184
A10.1	Introduction.....	184
A10.2	How do these provisions relate to Commonwealth legislation?.....	184
A10.3	Objectives.....	185
A10.4	Controls	186
A10.5	Co-Location Requirements.....	187
A10.6	Location.....	187



A10.7	Physical Design	188
A10.8	Public Health	188
A10.9	A1.10 Environmental Impacts	188
A10.10	Heritage Impacts	189
PART B	DEVELOPMENT- SPECIFIC CONTROLS.....	192
Section 1	Introduction	192
Section 2	Residential and Ancillary Development	193
B2.1	Siting, Design and Landscaping of Residential Development	193
B2.2	Energy Efficient Building Design	199
B2.3	Dual Occupancy and Secondary Dwelling Developments	199
B2.4	Tennis Courts.....	201
B2.5	Domestic Water Supply.....	202
B2.6	Water Supply for Rural Fire Service.....	203
B2.7	On-Site Effluent Disposal System	203
B2.8	Shipping Containers	204
B2.9	Group Homes (Permanent or Transitional)	204
B2.10	Bed and Breakfast Accommodation	205
B2.11	Home Business	208
B2.12	Home Industry.....	210
B2.13	Health Consulting Rooms	211
Section 3	Agricultural and Ancillary Development	213
B3.1	Introduction.....	213
B3.2	Protection of Rural Lands for Future Agricultural Uses.....	213
B3.3	Site Suitability for Particular Development	214
B3.4	Types of Agriculture	214
B3.5	Objectives.....	214
B3.6	Controls	215



B3.7	Farm Stay Accommodation	216
Section 4	Rural and Extractive Industries	218
B4.1	Introduction.....	218
B4.2	Objectives.....	220
B4.3	Controls	221
Section 5	Tourist-related Development	223
B5.1	Introduction.....	223
B5.2	Tourist and Visitor Accommodation.....	224
B5.3	Food and Drink Premises.....	225
B5.4	Indoor Recreation Facilities.....	226
Section 6	Other Commercial and Community Development	228
B6.1	Site Suitability for Particular Development	228
B6.2	Objectives for all Commercial Development.....	229
B6.3	Additional Controls for Animal Boarding and Training Establishments	229
B6.4	Function Centres	232
B6.5	Outdoor Recreation Facilities.....	233

RURAL LANDS DCP

PART A—MANAGING OUR RURAL LANDS





Part A

Managing our Rural Lands



THIS PAGE LEFT INTENTIONALLY BLANK



PART A MANAGING OUR RURAL LANDS

Section 1 Introduction

A1.1 Citation

This Development Control Plan (DCP) shall be referred to as the Wingecarribee Shire Rural Lands Development Control Plan (Rural Lands DCP).

A1.2 Date of Commencement

The provisions of this Plan were first adopted by Council on 11 August 2010 and came into effect on 18 August 2010.

Subsequent amendments have occurred as described in the Schedule of Amendments on Page 2.

A1.3 Land To Which This Plan Applies

The Rural Lands DCP applies to the following zones within the Shire:

- Zone RU1 – Primary Production
- Zone RU2 – Rural Landscape
- Zone E2 – Environmental Conservation
- Zone E3 – Environmental Management
- Zone SP3 - Tourist

A1.4 Associated Planning Instruments and Council Endorsed Specifications

Under NSW planning legislation, the Environmental Planning and Assessment Act 1979 (EP&A Act) applies to all lands managed by Wingecarribee Council. This Act contains provisions enabling a variety of statutory plans to be made, including State Environmental Planning Policies (Seeps), Regional Environmental Plans (REPs) and Local Environmental Plans (LEPs), of which Wingecarribee LEP (WLEP) 2010 is Council's primary planning instrument.

WLEP 2010 contains objectives and controls for a variety of zones throughout the Shire. Each different zone contains a land use table outlining controls relating to permissible and



prohibited land uses. The EP&A Act also enables Development Control Plans to be made and builds on the framework established in WLEP 2010.

A1.5 Maps contained in this Plan

The maps contained in the Plan are extracts from WLEP 2010. Applicants should not rely on the printed version of any LEP map extract in this document, but instead should consult the relevant maps which may be accessed from Council's website, www.wsc.nsw.gov.au

A1.6 Structure of this Plan

This Plan is divided into two Parts reflecting the key issues and major land uses affecting rural land. These Parts are:

Part A – Managing Our Rural Lands – applies to all development on land to which this Plan applies. This Part considers the location and type of rural land and the key environmental principles directing Council's approach to more specific controls.

Part B – Development-specific Controls – provides additional objectives and controls for various types of development permissible with consent in the zones to which this Plan applies, including:

- Residential and Ancillary Development
- Agriculture and Ancillary Development
- Rural and Extractive Industries
- Tourism-related Development
- Commercial and Community-related Development.

As much as possible, objectives and controls for development in the rural lands of the Shire have been incorporated in Part A of the Plan. Applicants must address all of the principles, objectives and controls contained in Part A and then check what additional requirements there may be under the relevant section of Part B.



Section 2 Classification and Distribution of Rural Lands

A2.1 Introduction

The Wingecarribee Our Future Strategic Plan 2002 used an Ecological Setting approach to the description of all land within the Shire, classifying it in accordance with the natural ecological characteristics and processes that are present on that land, taking into account the extent to which land uses have influenced natural ecological processes. This analysis provided the basis for the zoning of rural land under WLEP 2010. Land which was not attributed to the Urban Ecological Setting, that is, land outside the towns and villages, was attributed to either the Natural Bushland Ecological Setting or the Rural Ecological Setting depending on its overall appearance and assessment of ecological value. These Settings are explained below.

A2.2 The Natural Bushland Ecological Setting

The Shire is endowed with large areas of natural bushland, many of which show evidence of limited human intervention. These areas are acknowledged by Council as being of primary ecological significance for the Shire as a whole, and some are also of regional and even state significance.

Typical land uses in areas of natural bushland include rural-residential development; tourism and recreation facilities; National Parks, State Recreation Areas and Nature Reserves; Special Drinking Water Catchment Areas and State Forests.

These natural bushland areas are typified by larger scale land holdings (generally greater than 40 hectares), compared with towns and villages and with smaller properties within the Rural Ecological Setting.

The ecological value of these natural bushland settings is high, characterised by self-sustaining and high integrity natural ecosystems and ecological processes that predominate over human activity and non-native plants and animals.

By taking into account these ecological characteristics, as well as likely future development and land use potential, Council has classified a large part of the Shire as being part of the 'natural bushland ecological setting'. Ordinarily, this would apply to land that is:

- in private ownership with a contiguous area of more than 10 hectares, or
- a National Park, State Recreation Area or Bushland Reserve, or
- Special Drinking Water Catchment Area owned or controlled by the Sydney Catchment Authority or the Council.

Council wants to protect and preserve land within the natural bushland ecological setting as the Shire's major contribution to the achievement of ecological sustainability. Council is committed to achieving sustainable development and land use outcomes in the Shire's



natural bushland areas. This will have benefits for the preservation of biodiversity and important land and water resources, for the well being of the Shire's current and future communities and for the enjoyment of visitors to the Shire.

To achieve this goal, future planning for development and activities on land classified as being part of the natural bushland ecological setting must recognise the following ecological sustainability planning principles:

- a) the extent of human activity and development in the natural bushland ecological setting shall be managed to minimise disturbance with natural ecosystems and ecological processes.
- b) biodiversity conservation and ecological considerations shall be considered paramount.
- c) Potentially significant (critical) ecological resources shall be preserved.
- d) The design of development and on-going land management shall conserve existing ecological preservation values.
- e) All impacts of development and land use activities on natural systems shall be retained on-site.
- f) Development shall comply with the principles of Ecologically Sustainable Development in terms of design, construction and ongoing management.

It is important to note that potentially significant critical ecological resources have been identified as occurring within different areas of the natural bushland ecological setting, across the whole of the Shire. These include:

- g) Endangered Ecological Communities as defined by the NSW Scientific Committee;
- h) Known threatened species (Threatened Species Conservation Act and Wingecarribee Biodiversity Study);
- i) Wetlands (Wingecarribee Wetlands Management Strategy); and
- j) Riparian land (WLEP based on Sydney Catchment Authority's Strategic Land and Water Capability Assessments).

A2.3 Rural Ecological Setting

There are extensive areas of land within the Shire that display a general rural or agricultural land use character. Typical land uses include grazing; vineyards; orchards; potato farming; turf farming and other cropping; dams; rural-residential development (on holdings generally up to 40 hectares); local rural industries such as wineries, limited tourism accommodation and recreation activities. In some locations more intensive land uses occur, such as intensive livestock keeping; pine forestry plantations and extractive industries.



These areas are generally of a cleared pastoral nature, although many retain significant stands of remnant bushland, often because those specific locations are unsuited to agricultural uses. These areas may also retain naturally occurring streams and other watercourses, although the condition and character of stream beds, banks and riparian areas can be expected to vary. In these rural areas, natural ecosystems and ecological processes are generally highly disturbed.

By taking into account these ecological characteristics, as well as likely future development and land use potential, Council has been able to classify a large part of the Shire as being part of the 'rural ecological setting'.

Council is committed to achieving sustainable development and land use outcomes in the Shire's rural areas. This will have benefits for the conservation of biodiversity and the productive agricultural land and water resources, for the well being of the Shire's current and future communities, as well as for the enjoyment of visitors.

To achieve this goal, future planning for development and activities on land classified as being part of the rural ecological setting, must recognise the following ecological sustainability planning principles:

- a) Respect that natural ecological processes will generally remain secondary to productive rural and agricultural systems, excepting where ecological resources of critical significance are present.
- b) Existing vegetation, land and water resources shall be conserved where they are identified as having potential (critical) ecological significance.
- c) The design of development and ongoing land management techniques shall retain existing conservation values.
- d) Development and land use activities shall retain on-site any impacts on natural systems.
- e) Development shall comply with the principles of Ecologically Sustainable Development in terms of design, construction and ongoing management.

It is important to note that potentially significant (critical) ecological resources have been identified as occurring within different areas of the rural ecological setting, across the whole of the Shire. These include:

- a) Endangered Ecological Communities as defined by the NSW Scientific Committee;
- b) Known threatened species (Threatened Species Conservation Act and Wingecarribee Biodiversity Study);
- c) Regional and Local Primary Flora and Fauna Habitat Corridors (Wingecarribee Biodiversity Study);



- d) Core Flora and Fauna Habitat (meaning natural bushland with only moderate – low levels of disturbance with an area greater than 10 hectares when located in a rural small-holdings locality only);
- e) Wetlands (Wingecarribee Wetlands Management Strategy); and
- f) Riparian land (WLEP based on Sydney Catchment Authority’s Strategic Land and Water Capability Assessments).

A2.4 Agricultural Land Classification

The NSW Department of Primary Industries has classified all agricultural land within the Shire, grading it from Class 1 (best) to Class 5 (worst) according to its suitability for a wide range of agricultural activities. Class 1 land has few constraints to agricultural production, so a wide range of crops can be profitably grown; while Class 5 land has severe constraints and is, in general, unsuited to agriculture. These classifications were based on field surveys and the interpretation of remotely sensed data.

The distribution of land classifications is shown in [Figure A2.1](#) below and summarised in the table following.

NB. The PDF version of this DCP (on Council’s website, or provided on disk) will show the map in colour and allow for clear identification of classes. To assist in interpreting the paper-based version of this document, an indication of the location of each class is shown on the map.



Class	Description	Have all, or nearly all of the following characteristics	Locations within the Shire
1	Arable land suitable for intensive cultivation where constraints to sustained high levels of agricultural production are minor or absent.	<ul style="list-style-type: none"> • Productivity is high to very high for a very wide range of field crops adapted to the area. • Access to local and export markets is satisfactory. • Local or regional infrastructure to support intensive forms of agriculture is present and a ready supply of suitable labour is available, if required. • Potential for land use conflict with neighbours as a result of standard agricultural practices is low. • Slopes are level to very gently inclined. • Soils are deep. • The land is capable of sustaining regular cultivation. • The soil profile is well drained to moderately well drained. • Erosion hazard is low, so only simple soil conservation management practices are required to protect the soils from erosion. • Any soil physical and chemical constraints are capable of being economically overcome for a very wide range of field crops. • A recurrent extreme of climate does not seriously affect productivity. • Potential economic losses due to flooding are very low, in the long term. • The level of economic constraint from factors such as weeds, site contamination, standing timber 	There is no Class 1 land within the Shire.



Class	Description	Have all, or nearly all of the following characteristics	Locations within the Shire
		and feral animals is very low.	
2	Arable land suitable for regular cultivation for crops, but not suited to continuous cultivation. It has a moderate to high suitability for agriculture but edaphic (soil factors) or environmental constraints reduce the overall level of production and may limit the cropping phase to a rotation with sown pastures.	<ul style="list-style-type: none"> • Productivity is high to very high for a wide range of field crops adapted to the area. • Access to local and export markets is satisfactory. • Local or regional infrastructure to support intensive forms of agriculture is present and a ready supply of suitable labour is available, if required. • Potential for land use conflict with neighbours as a result of standard agricultural practices is low. • Slopes are level to gently inclined. • Soils are deep to moderately deep. • The land is capable of sustaining regular cultivation; however, conservation tillage practices may be required. • The soil profile is either moderately well drained or rapidly drained. • Erosion hazard is low to moderate, so soil conservation measures may need to be adopted to avoid erosion. • Any soil physical and chemical constraints are capable of being economically overcome for a wide range of field crops. 	Within the eastern part of the Shire around Kangaloon, Robertson, Avoca and Fitzroy Falls.



Class	Description	Have all, or nearly all of the following characteristics	Locations within the Shire
		<ul style="list-style-type: none"> • Recurrent extremes of climate are unlikely to affect productivity. • Potential economic losses due to flooding are low, in the long term. • The level of economic constraint from factors such as weeds, site contamination, standing timber and feral animals is low. 	
3	<p>Grazing land or land well suited to pasture improvement. It may be cultivated or cropped in rotation with sown pasture. The overall production level is moderate because of edaphic or environmental constraints. Erosion hazard, soil structural breakdown or other factors, including climate, may limit the capacity for cultivation and soil conservation or drainage works may be</p>	<ul style="list-style-type: none"> • Productivity is high for locally adapted pastures and moderate for crops well suited to the area. • Access to local and export markets is satisfactory. • Local and regional infrastructure to support extensive forms of agriculture is present, and a ready supply of suitable labour is available. • Potential for land use conflict with neighbours as a result of standard agricultural practices may restrict agricultural activities. • Slopes are level to moderately inclined. • Soils are moderately deep to shallow. • The land has moderate to limited suitability for cultivation, so cultivation is only sustainable in rotation with pastures. 	<p>Through the central part of the Shire from the northern villages through to Moss Vale, Sutton Forest, Exeter and Bundanoon.</p>



Class	Description	Have all, or nearly all of the following characteristics	Locations within the Shire
	required.	<ul style="list-style-type: none"> • The soil profile is well drained to imperfectly drained. • Erosion hazard is low to high, so intensive measures of soil conservation may be required to control erosion in the long term. • Soil physical and chemical properties may limit crop and pasture productivity. • Recurrent extremes of climate may affect productivity. • Potential economic losses due to flooding are moderate, in the long term. • The level of economic constraint from factors such as weeds, site contamination, standing timber and feral animals is moderate. 	
4	<p>Land suitable for grazing but not for cultivation.</p> <p>Agriculture is based on native pastures or improved pastures established using minimum tillage techniques. Production may be seasonally high but the overall production level is low as a result of major</p>	<ul style="list-style-type: none"> • Productivity levels for locally adapted pastures are low to moderate; however, productivity for selected tree crops may be high. • Access to local and export markets may be restricted by location. • Local infrastructure to support extensive forms of agriculture is present, however suitable labour resources may be limited. • Potential for land use conflict with neighbours as a result of standard agricultural practices may restrict agricultural activities. 	Through the western part of the Shire.



Class	Description	Have all, or nearly all of the following characteristics	Locations within the Shire
	environmental constraints.	<ul style="list-style-type: none"> • Slopes are level to steeply inclined. • Soils are mostly shallow. • The land is unsuitable for cultivation, but minimum tillage techniques can be used to establish perennial pastures. • The soil profile is well drained to poorly drained. • Erosion hazard is low to very high; intensive measures of soil conservation may be required, but erosion may still be significant in the long term. • Soil physical and chemical properties limit crop and pasture growth, and low productivity levels limit the ability to economically manage this constraint. • Recurrent extremes of climate are likely to affect productivity. • Potential economic losses due to flooding are high, in the long term. • The level of economic constraint from factors such as weeds, site contamination, standing timber and feral animals is high. 	
5	Land unsuitable for agriculture, or at best suited only to light grazing. Agricultural production is	<ul style="list-style-type: none"> • Productivity levels for all types of agricultural crops and pastures are very low. • Access to local and export markets may be very restricted by location. • Local infrastructure to support extensive forms of agriculture may be absent, as may suitable 	Through the northern, western and southern parts of the Shire.



Class	Description	Have all, or nearly all of the following characteristics	Locations within the Shire
	<p>very low or zero as a result of severe constraints, including economic factors which prevent land improvement.</p>	<p>labour resources.</p> <ul style="list-style-type: none"> • Extremes of slope can be expected. • The land is unsuitable for cultivation. • The soil profile is very poorly drained. • Erosion hazard is extreme, and economic control using conventional soil conservation measures is impractical. • Soil physical and chemical properties present an extreme limitation to the growth of agricultural plant species. • Recurrent extremes of climate may seriously affect productivity. • Potential economic losses due to flooding are high, in the long term. • The level of economic constraint from factors such as weeds, site contamination, standing timber and feral animals is very high to extreme. 	

A2.5 Zone Distribution & Objectives

A2.5.1 Introduction

The distribution of the Natural and Rural Ecological Settings, together with the distribution of the various classes of agricultural land, forms the basis for the allocation of rural land to the relevant zones under WLEP 2010.

This Plan addresses land uses within the three rural zonings – RU1 Primary Production, RU2 Rural Landscape and E3 Environmental Management, as well as the SP3 Tourist zone. The general distribution and nature of each zone is considered below. Applicants are reminded that the maps and objective statements below are indicative summaries only of the detail contained in WLEP 2010. It is essential to consult WLEP 2010 directly to confirm the location of and objectives for specific zonings and types of permissible development.

A2.5.2 Primary Production (RU1)

The RU1 zoned land is located in the western edge of the Shire as indicated in Figure A2.2 below.

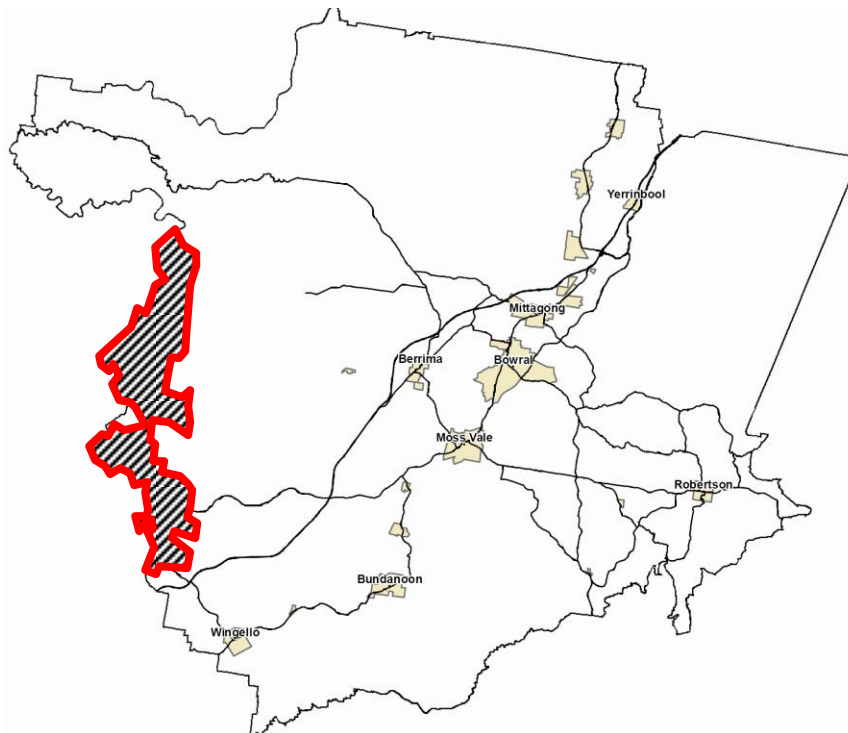

Figure A2.2 – General distribution of RU1 (Primary Production) land

The primary purpose of this zone is to provide for diversity of primary industry activities which are sustainable in terms of maintaining and enhancing the natural resource base of

the Shire. Council also seeks to ensure that such activities do not cause fragmentation or alienation of the land.

This is the only zone within which Council permits, with consent, intensive livestock agriculture in an effort to ensure that potential conflicts between such land uses and other residents of the Shire are minimised.

A2.5.3 Rural Landscape (RU2)

The extent of the RU2 zoned land is greater than that of the RU1 zoned land, being located through the western and southern areas of the Shire as indicated in Figure A2.3 below.

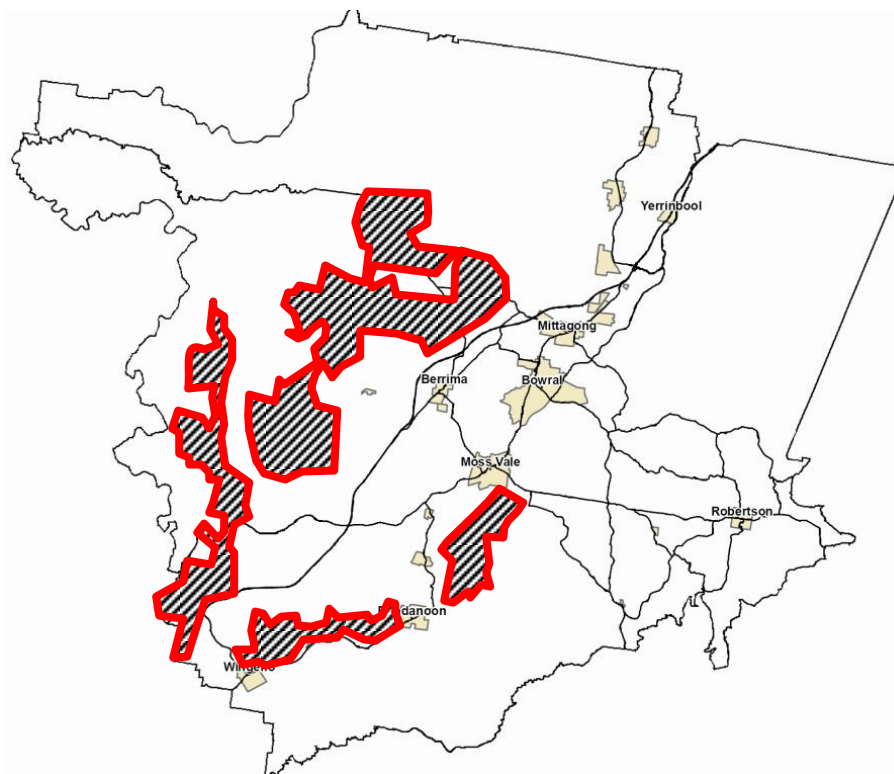

Figure A2.3 – General distribution of RU2 (Rural Landscape) land

Council's intentions for the RU2 land are to provide for a range of compatible land uses which encourage sustainable primary industry production through maintaining and enhancing the natural resource base of the Shire, as well as maintaining the rural landscape character of the land.

A2.5.4 Environmental Management (E3)

The range of E3 zoned land is far more extensive than either the RU1 or RU2 zoned land, being located right across the Shire from the western to the eastern boundary as indicated in Figure A2.4 below. This figure gives a visual interpretation only of the range of the E3 zoned land as small pockets scattered across the Shire have not been included. Again, applicants are reminded to consult the WLEP 2010 maps and instrument to confirm the zoning of a specific parcel of land.

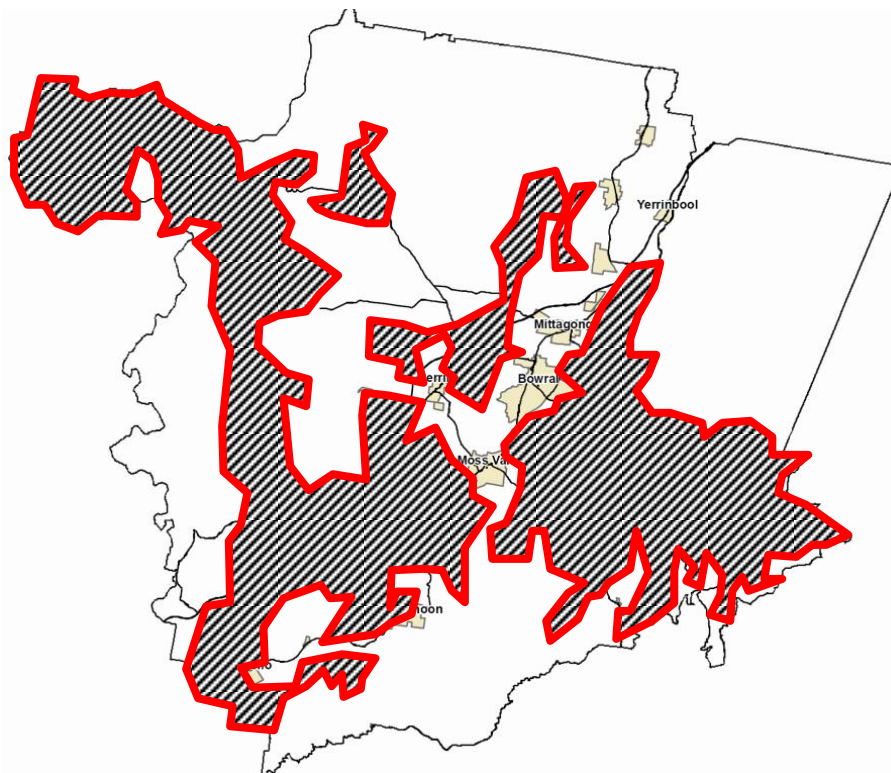

Figure A2.4 – General distribution of E3 (Environmental Management) land

The primary purpose of the E3 zoned land is to protect, manage and restore areas of the Shire with special ecological, scientific, cultural or aesthetic values. Development is permitted, provided it does not have an adverse effect on those values.

A2.5.5 SP3 Tourist

There are two areas of SP3 Tourist land within the Shire under WLEP 2010, one to the immediate west of Welby, the other to the south of Moss Vale, as indicated in Figures A2.5, A2.6 and A2.7 below. Because both locations are within a rural context this zone is included in this Rural Lands Development Control Plan.

The objectives for this land are:

- ▶ To provide for a variety of tourist oriented development and related uses.
- ▶ To ensure that development has proper regard to environmental constraints and minimises any off and on site impacts on bio-diversity, water resources and natural landforms.
- ▶ To ensure that development is sympathetic to the rural setting and landscape features of the site and minimises impacts on the scenic value from adjacent and nearby development and land use activity.

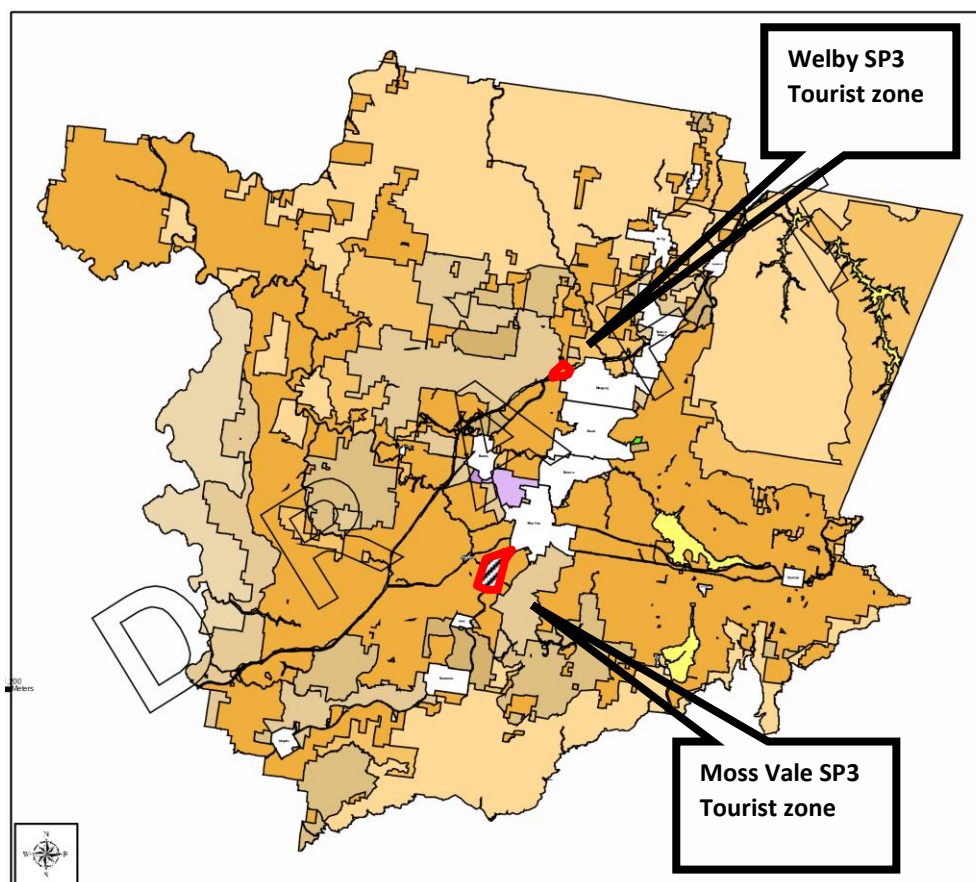

Figure A2.5 – Location of SP3 (Tourist) land

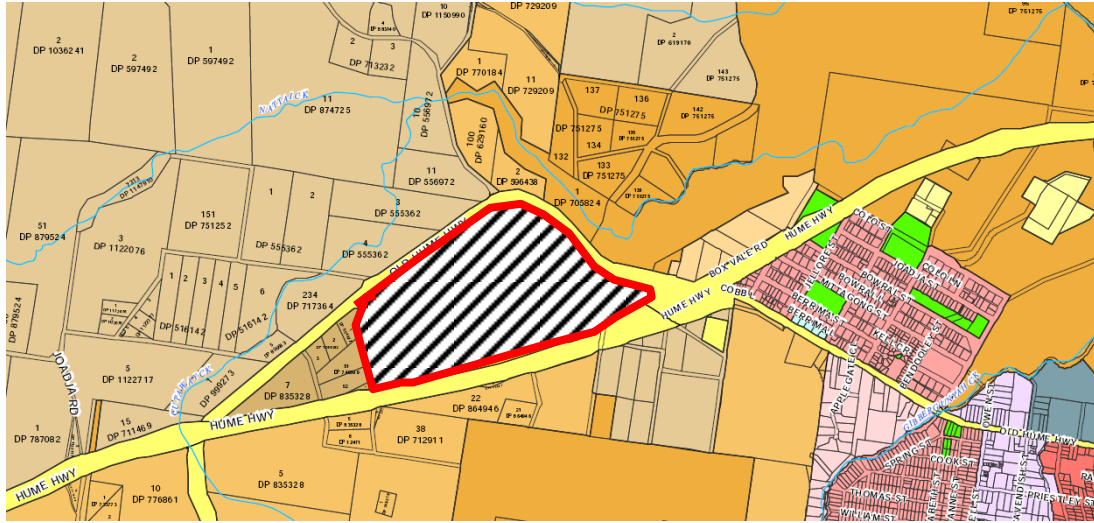

Figure A2.6 –SP3 (Tourist) land at Welby

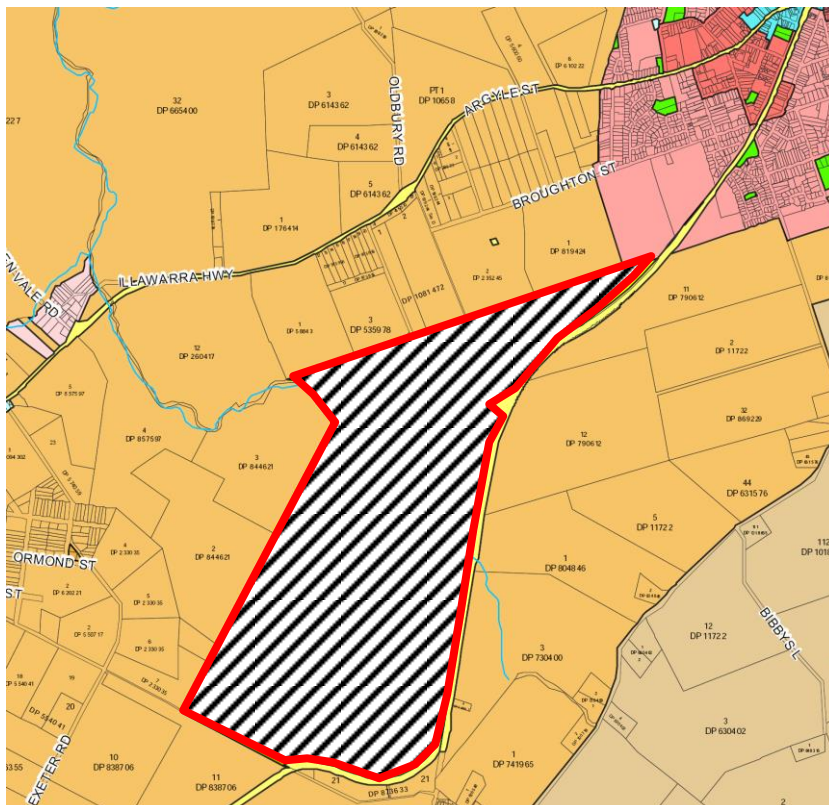

Figure A2.7 –SP3 (Tourist) land at Moss Vale



A2.5.6 E2 Environmental Conservation

The E2 Environmental Conservation zone is located throughout the Shire and applies to all non-urban land owned by a public authority. The location of the E2 land and the objectives of the zone may be viewed in the relevant section of the land use table in Wingecarribee Local Environmental Plan 2010.

A2.6 The Value of Rural Land

The principles, objectives and controls contained in this Plan focus on recognising, protecting and enhancing the ecological value of rural land, thereby, Council believes, protecting and enhancing the agricultural, residential and tourist value of the land. Council does recognise that rural land has important economic and cultural values which can, and do, make a significant contribution to the amenity and prosperity of the Shire.

Land uses permissible with consent in each zone to which this Plan applies offer a range of opportunities for owners of rural land to achieve an economic return other than through traditional agriculture. In some cases it is possible to combine a range of land uses, such a farm stay in association with an agricultural activity, to provide a more sustainable economic base.

However, Council believes that, without the protection and enhancement of the ecological value of the land, its economic and cultural values cannot be sustained.

A2.7 Subdivision of Rural Land

WLEP 2010 applies a minimum lot size of 40 hectares to all land within the Shire to which this Development Control Plan applies. The maintenance of this minimum is essential in order to protect its ecological value, retain the agricultural value of the land and retain the visual amenity of the Shire's rural landscape.

Many rural properties across the Shire are less than this 40ha minimum, but these smaller lots reflect the historical development of the Shire and are not to be considered a precedent for making application to Council for ad hoc rezoning and subdivisions outside of the context of WLEP 2010.

The Rural Lands State Environmental Planning Policy (SEPP) reinforces Council's position in this regard, identifying the following Rural Subdivision Principles as the basis for assessing any future rural subdivision. Any such consideration must ensure:

- (a) the minimisation of rural land fragmentation,
- (b) the minimisation of rural land use conflicts, particularly between residential land uses and other rural land uses,



- (c) the consideration of the nature of existing agricultural holdings and the existing and planned future supply of rural residential land when considering lot sizes for rural lands,
- (d) the consideration of the natural and physical constraints and opportunities of land,
- (e) that planning for dwelling opportunities takes account of those constraints.

A2.7.1 Allotment Sizes

Applicants are directed to the minimum lot size maps under WLEP 2010 which indicate the subdivision potential for any lot. Where proposed subdivision would create an allotment below the minimum lot size, certain provisions of WLEP 2010 apply and applicants are advised to consult with Council to determine the extent to which any variation of the minimum lot size may be permissible.

Where subdivision is proposed a merits approach shall be taken in terms of assessing existing patterns of development and issues such as effluent disposal, access, drainage etc.

Note: Allotment sizes are expressed as minimums. It may be necessary for larger allotments to be created where other environmental constraints occur, for instance to incorporate and retain areas of remnant vegetation, to adequately dispose of stormwater by infiltration, and the retention of prominent land forms.



Section 3 Ecologically Sustainable Development

A3.1 Introduction

To achieve the objectives of protecting and enhancing the ecological value of rural land, and through them, protecting and enhancing the economic and cultural activities and values of the land, Council is committed to the principles of Ecologically Sustainable Development (ESD).

ESD is development which utilises the community's resources in such a way that existing ecological processes, on which all life depends, are maintained, protected and enhanced. The principles of ESD incorporate:

- (a) the precautionary principle - if there are threats of serious or irreversible environmental damage, lack of full scientific certainty should not be used as a reason for postponing measures to prevent environmental degradation,
- (b) inter-generational equity - the present generation should ensure that the health, diversity and productivity of the environment are at least maintained, and, preferably, enhanced for the benefit of future generations,
- (c) conservation of biological diversity and ecological integrity - new development must ensure that there is no loss of biological diversity or ecological integrity,
- (d) improved valuation, pricing and incentive mechanisms - environmental factors should be incorporated into the valuation and pricing of assets and services through such principles as:
 - (i) polluter pays - those who generate pollution and waste should bear the cost of containment, avoidance or abatement,
 - (ii) full costing - the users of goods and services should pay prices based on the full life cycle of the costs of providing those goods and services, including the use of natural resources and assets and the ultimate disposal of any waste,
 - (iii) cost-effectiveness - environmental goals should be pursued in the most cost-effective way, by establishing incentive structures, including market mechanisms, that enable those best placed to maximise the benefits or minimise the costs to develop their own solutions and responses to environmental problems.

To achieve ESD applicants need to comply with the DA requirements described below and the objectives and controls detailed within the remaining Sections of this Part of the Plan, as



well as address additional relevant objectives and controls contained in subsequent Parts of this Plan as relevant to the particular type of development proposed.

A3.2 Development in Sydney's Drinking Water Catchments

A3.2.1 Introduction

The Sydney Catchment Authority (SCA) manages and protects Sydney's drinking water catchments through the regulation of developments in the catchment areas, consistent with the *Drinking Water Catchments Regional Environmental Plan No 1* (the REP), or its equivalent.

Land within Sydney's drinking water catchments must be developed in accordance with the requirements of the REP.

A3.2.2 Objectives

- (a) To ensure water catchments deliver high quality water while sustaining diverse and prosperous communities;
- (b) To improve water quality in degraded areas where quality is not suitable for the relevant environmental values; and
- (c) To maintain or improve water quality where it is currently suitable for the relevant environmental values.

A3.2.3 Controls

- (a) Under the REP, Council cannot grant development consent unless it is satisfied the development will have a neutral or beneficial effect on water quality. In assessing whether a proposed development has a neutral or beneficial effect on water quality, Council must be satisfied that:
 - (i) the development has no identifiable potential impact on water quality; or
 - (ii) will contain any such impact on the site of the development and prevent it from reaching any watercourse, water body or drainage depression on the site; or
 - (iii) will transfer any such impact outside the site by treatment in a facility to the required standard and disposal approved by the consent authority; and
- (b) the development incorporates the SCA's current recommended practices (or equivalent standards and practices) which represent best industry or development practice in terms of maintaining water quality.
- (c) Any proposed development which Council believes does not have a neutral or beneficial effect on water quality must be referred by Council to the SCA, for a decision on concurrence, before development approval can be given. The SCA in granting concurrence may impose conditions to ensure a neutral and beneficial



impact on water quality. If the SCA is not satisfied a neutral and beneficial impact on water quality can be achieved, concurrence will be withheld and Council will not be able to approve the development. For information on the REP and the SCA's current recommended practices, applicants should refer to the SCA's website at www.sca.nsw.gov.au

- (d) To enable Council and the SCA to assess whether a development will have a neutral or beneficial effect on water quality, all development applications in the drinking water catchments must be accompanied by a Water Cycle Management Study. The contents of a Water Cycle Management Study, including the information, reports and modelling required, will vary according to the type of development and the risks it poses to water quality, with more in depth studies required for developments that pose a higher risk. The SCA has published the Neutral or Beneficial Effect on Water Quality Assessment Guidelines to assist councils and applicants (available on the SCA's website at www.sca.nsw.gov.au) which categorises developments into five modules according to complexity and the risk to water quality.
- (e) A Water Cycle Management Study accompanying a development application must include the following components:
- (i) Clearly outline the development proposed, including a detailed site plan which includes site constraints
 - (ii) A summary and location of the water quality control measures proposed as part of the development
 - (iii) A statement, based on the information in the Water Cycle Management Study, as to whether the development has a neutral or beneficial effect on water quality, consistent with the SCA's Neutral or Beneficial Effect on Water Quality Assessment Guidelines.
- (f) In addition, the Water Cycle Management Study should contain the following reports or modelling.

Development Type

Information required in the

Water Cycle Management Study

Minor developments which represent a very low risk to water quality. Limited to very minor alterations and additions to residential houses in seweraged areas.

An assessment, consistent with the SCA's Neutral or Beneficial Effect on Water Quality Assessment Guidelines, as to whether the development will have any identifiable potential impact on water quality. If there are any potential impacts then the development requires the information outlined in Module 1.



<p>Less complex developments which represent a minor risk to water quality. These include typically new single dwellings, dual occupancy or secondary dwellings, or alterations and additions to existing dwellings, in sewered areas.</p>	<p>Modelling using the Small-scale Stormwater Quality Model</p> <p>Conceptual erosion and sediment controls to be applied during construction</p>
<p>Developments considered to be moderately complex which represent a medium to high risk to water quality. These include typically multi-dwelling housing and small lot residential subdivisions in sewered areas.</p>	<p>Stormwater quality modelling (using either the Small-scale Stormwater Quality Model or the MUSIC stormwater quality model)</p> <p>Conceptual Erosion and Sediment Control Plan or a more detailed conceptual Soil and Water Management Plan</p>
<p>Developments considered to be highly complex or non-standard developments which represent the highest risk to water quality. These include typically major commercial developments, and tourism and recreational developments.</p>	<p>Stormwater quality modelling (using either the Small-scale Stormwater Quality Model or the MUSIC stormwater quality model)</p> <p>Conceptual Soil and Water Management Plan</p> <p>On-site Wastewater Management Report (if relevant)</p> <p>Development specific pollutant assessment requirements</p>
<p>(g) Applicants and consultants are strongly recommended to refer to the SCA publication <i>Developments in Sydney's drinking water catchments – water quality information requirements</i> (available on the SCA's website at www.sca.nsw.gov.au). This publication outlines in detail the content requirements for a Water Cycle Management Study, and the different reports and modelling which need to be included, according to the type and scale of development proposed.</p>	

A3.3 Protection of Watercourses and Riparian Lands

Clause 7.4 of Wingecarribee LEP 2010 addresses objectives and controls for the protection, enhancement and management of the ecological, scientific, cultural and aesthetic values of regional wildlife habitat corridors, natural water bodies and riparian land within the Shire. This clause applies to land identified on the Natural Resources Sensitivity Map as regional wildlife habitat corridor, or natural waterbodies and riparian land.

Riparian Land means land adjoining a natural waterbody that is:

- within 50m from the top of bank of Category 1 streams (marked red on Map A7.1), and



- within 30m from the top of bank of Category 2 streams (marked blue on Map A7.1), and
- within 10m from the top of bank of Category 3 streams (marked green on Map A3.1).

Applicants are directed to the controls within the Wingecarribee LEP with regard to proposed development close to an identified riparian corridor.

A3.4 Statement of Environmental Effects

The Environmental Planning and Assessment Act requires that all Land Use Applications be accompanied by a Statement of Environmental Effects (SEE). A SEE is a report outlining the likely impacts of the proposal, and the proposed measures that will mitigate these impacts.

The Statement includes written information about the proposal that cannot be readily shown on plans and drawings. It is the applicant's responsibility to ensure that the SEE is appropriate to the scale and location of the proposed development. The aim of a SEE is to assist in the assessment of a DA and therefore, any application which does not include a SEE, or submits a SEE which does not allow the application to be adequately assessed, will be rejected.

A SEE will usually contain:

- (a) A detailed description of the proposed development;
- (b) An assessment of the proposal against the zoning provisions and relevant clauses of WLEP 2010, this Development Control Plan, and relevant State and Regional Planning policies);
- (c) A description of the local environment and existing development in the vicinity of the site;
- (d) A Site Analysis and Assessment report (see below) which describes the features of the site of the proposed development, including, but not limited to, topography, vegetation, access, services, constraints and opportunities and an assessment of how the proposed development fits within this context. Applicants should refer to subsection A3.3 below for further detail;
- (e) A discussion of potential environmental effects of the proposed development (eg visual impact, tree removal, increased traffic) and how these will be addressed. Specialist technical reports may be necessary in some cases. Applicants should refer to relevant sections of the Plan to see Council's objectives and controls relating to these matters.

Before commencing a SEE, applicants are advised to read through the remaining Sections of Part A and the relevant section(s) of Part B of this Plan which deal with the specific development type proposed.



A3.5 Site Analysis

Site Analysis is the process of identifying the main opportunities and constraints of the site as well as identifying the existing patterns and design styles of surrounding development. Every land use application which involves significant alteration to the site whether through development of currently vacant land, extensive renovation of an existing building, or demolition, must be accompanied by an appropriate Site Analysis Report.

The Site Analysis Report shall comprise:

- (a) A Site Analysis Drawing, identifying the following site features:
 - (i) The slope and contours of land;
 - (ii) The location and nature (whether perennial or intermittent) of any watercourses as indicated on Council's Resources Sensitivity Maps,
 - (iii) The location and nature of waterways, water bodies or drainage depressions.
 - (iv) The location and nature of associated riparian corridor requirements, potential flooding or drainage characteristics;
 - (v) The orientation of the land including the marking of true north;
 - (vi) The location, extent and nature of any existing development, buildings and activities upon, adjacent and in proximity to the land;
 - (vii) The location and nature of any utility services;
 - (viii) The location and description of any trees and vegetation upon, adjacent and in proximity to the land;
 - (ix) The existing means of vehicle and pedestrian access;
 - (x) Any items or places of known Aboriginal and European cultural heritage;
 - (xi) The direction and nature of prevailing climate characteristics such as wind direction and rainfall;
 - (xii) Any potential bush fire threat;
 - (xiii) Any significant views and vistas to the land, particularly from a public place or from the land itself; and
 - (xiv) The location and nature of any other known constraint to development of the land, including potential soil contamination, noise sources, geotechnical issues.

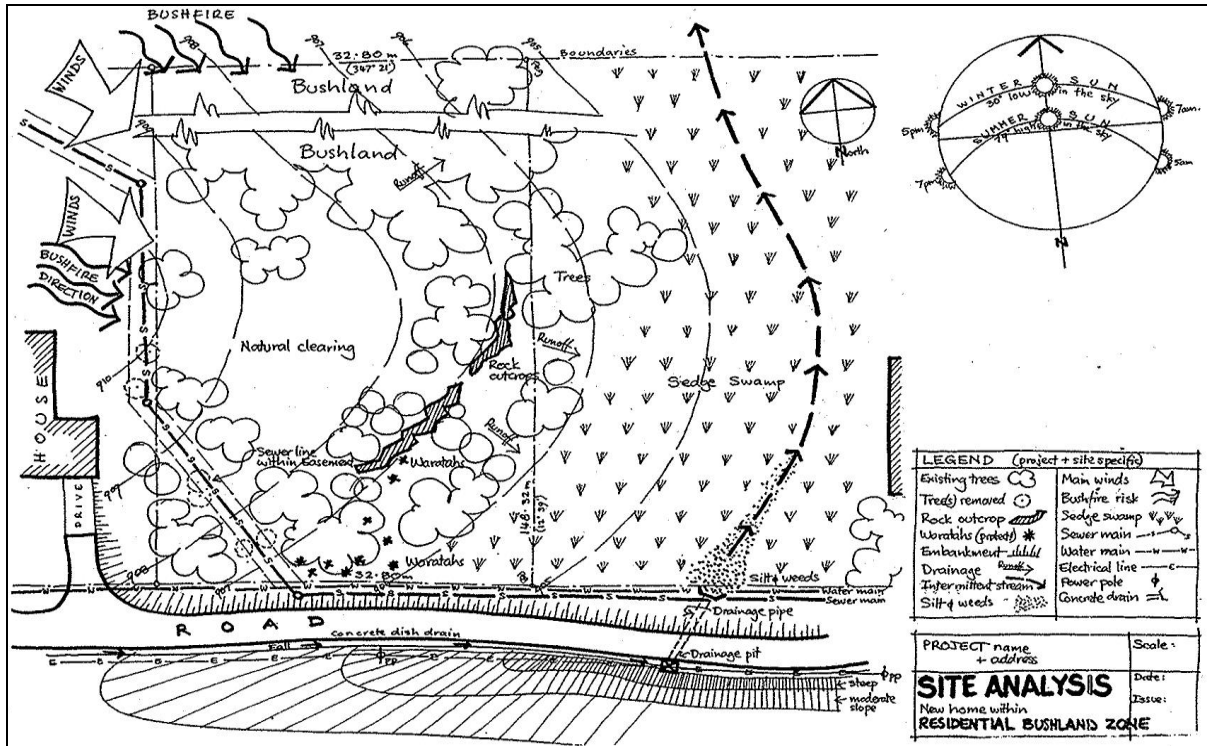

Figure A3.1 - Sample Site Analysis Drawing

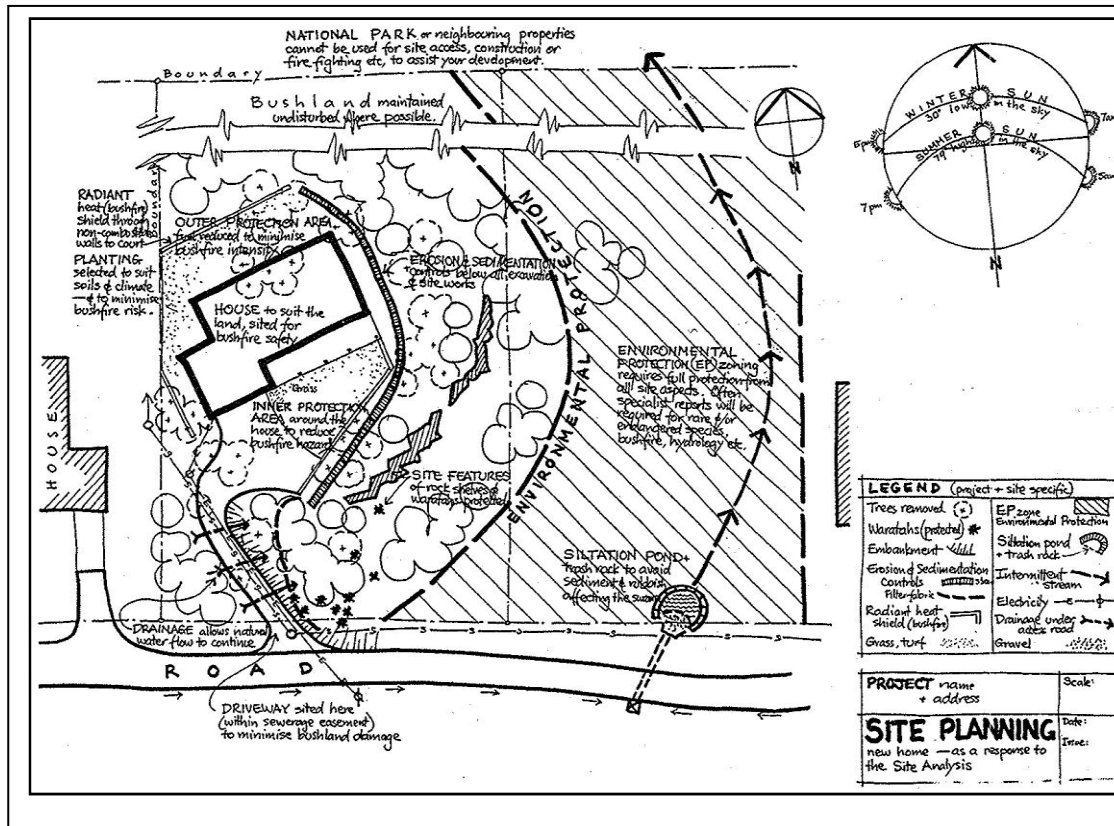

Figure A3.2 - Sample Design Principles Drawing



- (b) A written statement explaining how the site conditions have been interpreted into the design principles that guide the new development.

A3.6 Cut and Fill

A3.6.1 Introduction

In undertaking the site analysis, applicants are reminded that Council expects new development be designed to respond to a site's topography. Cut and fill is not considered an acceptable alternative to responsive design. Excessive cutting and filling of a site disturbs the natural soil profile and results in built form that is not sensitive to the existing landform on a site.

A3.6.2 Objectives

- a) Encourage stepping of buildings in response to existing topography.
- b) Minimise disturbance to existing landforms and soil profile.
- c) Minimise use of retaining walls.

A3.6.3 Controls

- a) Where the cut and fill objectives cannot be met, the development must be stepped in order to accommodate the contours of the site.
- b) Any cut and fill required shall comply with the maximum controls set out in Clause 7.3 (Earthworks) of Wingecarribee Local Environmental Plan 2010.

A3.7 Siting of Rural Buildings

In preparing a site analysis, particular attention should be given to the following objectives and controls for the siting and design of buildings within a rural location.

Generally, the location of rural buildings is based on practical considerations regarding the efficient undertaking of rural activities. However it is also important that consideration be given to the impact of these buildings on the rural landscape. Rural buildings can be an attractive addition to the environment if located correctly and constructed from materials which soften into the landscape as they age.

Also, in recent years, Council has noticed the tendency to locate residential dwellings where they are more visible within the rural landscape, including along ridge lines.

NB: Council no longer permits development on ridge lines in rural areas.

In future, the assessment the location and style of rural buildings, including dwellings, will be based on an assessment of the Site Analysis report with regard to the following guidelines:



- (a) The maximum height of any non-residential building shall be determined by Council staff with reference to the objectives of the zone, the location of the proposed development and any relevant environmental and amenity considerations.
- (b) No single rural building or structure shall generally occupy a ground level building footprint of more than 600 square metres (except as permitted in Section B6.5.2 – Equine Facilities). The building footprint excludes any area on which works or structures are carried out or constructed beneath the natural ground level, provided disturbance of the natural ground surface is kept to a minimum and there is no adverse visual or environmental impact.
- (c) The total area of all land occupied by the ground level building footprint of all rural buildings and other structures shall not generally exceed a total ground level footprint of 1000 square metres (except as permitted in Section B6.5.2 – Equine Facilities), excluding any area on which works or structures are carried out or constructed beneath the natural ground level.
- (d) All rural buildings are generally to be within building envelopes that are separated from each other by a distance of not more than 30 metres and not less than 5 metres.
- (e) No rural building or structure is to be located closer than 20 metres from any public road, unless assessed by Council as appropriate due to site constraints.
- (f) Rural buildings and structures shall be constructed from non-reflective materials. Zinalume is not permissible.
- (g) Have regard to applicable Landscape Conservation controls.

A3.8 Temporary Development

A3.8.1 Caravan Occupancy on site whilst erecting a dwelling

Prior written approval of Council required, with the following to be complied with:

- a) Occupation of caravan permitted only once the approved dwelling has substantially commenced construction, ie. footings/slab inspected and poured.
- b) Occupation of the caravan is permitted for a period of twelve months or for the duration of the building construction period (whichever is the shorter period)
- c) Adequate ablution facilities and effluent disposal systems are provided to Council's satisfaction.



Section 4 Vegetation Management

A4.1 Introduction

The controls in this section of the Plan apply to all forms of rural development. Council is committed to the preservation and enhancement of existing stands of vegetation, vegetation corridors and important tree specimens across the Shire. This preservation and enhancement occurs through objectives and controls for tree and vegetation preservation, new tree plantings along property boundaries, weed management, roadside management, and landform and vegetation modifications.

A4.2 The Importance of Biodiversity

A4.2.1 What Biodiversity?

Biodiversity is the variety of all life forms – the different plants, animals and micro-organisms, genetic variety and the natural systems of which they form a part. The significance of biodiversity stems from its role in maintaining the physical environment and food chain on which humans depend, and for the value of bio-resources which they provide.

A4.2.2 Why is Biodiversity so important?

- (a) Biodiversity is the cornerstone of natural systems which are essential in maintaining water quality, the quality of our atmosphere, the cycling on nutrients, the formation of soils, and the disposal of wastes.
- (b) Biodiversity provides bio-resources which provide a reserve for food species, medicinal drugs, and other useful products.
- (c) Biodiversity is an integral component of landscape health.
- (d) Biodiversity significantly contributes to viability of major industries such as agriculture, tourism, forestry, and fisheries.
- (e) Biodiversity is also intrinsically important and the community values native's plants and animals in their own right for aesthetic and recreational reasons and for the contribution that they make to our health and wellbeing, and our identity and "sense of place".

A4.2.3 Current Issues with regard to Biodiversity

- (a) The number of "threatened species" in the Shire is increasing
- (b) Habitat is declining due to land clearing and degradation. (rate of decline is not well monitored)



- (c) Limited public knowledge of local threatened/endangered species/communities, for example it is not well known that koalas are locally indigenous
- (d) No icon to focus attention and motivate community
- (e) The protection and connectivity of isolated parcels of habitat on private and public land.
- (f) Increasing impact of noxious and environmental weeds and predation by feral animals.

A4.2.4 What can individuals do?

- (a) Increase the biodiversity of your backyard by planting a variety of plant species, preferably natives.
- (b) Provide More variety, and preferably more natives, in own backyard
- (c) Control invasive weed species and feral animals
- (d) Learn and get involved in bush care, bird watching or bush walking groups
- (e) Use Chemicals wisely and choose ones that are the least toxic
- (f) Create habitat for native fauna by planting local native species, incorporating logs and rocks as well.

A4.2.5 What could Council do?

- (a) Undertake ground-truthing of the Shire's Endangered Ecological Communities and species
- (b) Be a leader in biodiversity on Council-managed land
- (c) Introduce policies that restrict development on recognised endangered species
- (d) Increase community's knowledge associated with biodiversity and promote the economical, social and environmental values of biodiversity throughout the Shire
- (e) Maintain the connectivity and viability of areas of native vegetation that form valuable wildlife corridors
- (f) Develop strategies to protect and preserve areas that are known to contain threatened and endangered flora and fauna species.
- (g) Monitor, review and report on Council programs that impact on Biodiversity.



A4.3 Vegetative Barrier Planting, Hedging & Row Plantings

A4.3.1 Introduction

In recent years, continuous, unmanaged plantings along property boundaries of fast growing trees, particularly *Cupressocyparis leylandii* (Leylandii), have significantly altered the visual appearance of many of the rural areas across the Shire.

Whilst Council recognises that there may be a need to create windbreaks, delineate space or create privacy through tree plantings, the use of inappropriate species which are fast growing and never trimmed can cause serious amenity loss for neighbouring properties and the rural landscape in general.

Just as the spaces between buildings are as important as the buildings themselves in the urban environment, so the spaces between trees and vegetative plantings are as important as the plantings themselves in the rural environment.

Tall, dense tree plantings can cause loss of solar access to neighbouring properties, changes in micro climatic conditions, impacts on the growth of nearby native flora, and the loss of the views and vistas which form an important part of the cultural landscape for both residents and visitors. Dangerous traffic conditions, such as black ice spots on roads, can be caused by such plantings blocking essential early morning, frost thawing, sun light on to roads during winter.

Council strongly believes that the recent proliferation of dense plantings of fast growing species, particularly *Leylandii*, is having a detrimental effect on the visual amenity of the landscape. An independent views and vistas scenic landscape review across the Shire, conducted by DEM Consulting was reported to Council in September 2010. As a result of that report, Council resolved to implement the following controls to all rural land fronting roads with views and vistas rated by the consultants as 'Very High' and 'High', as indicated on the following [Figure A4.1](#).

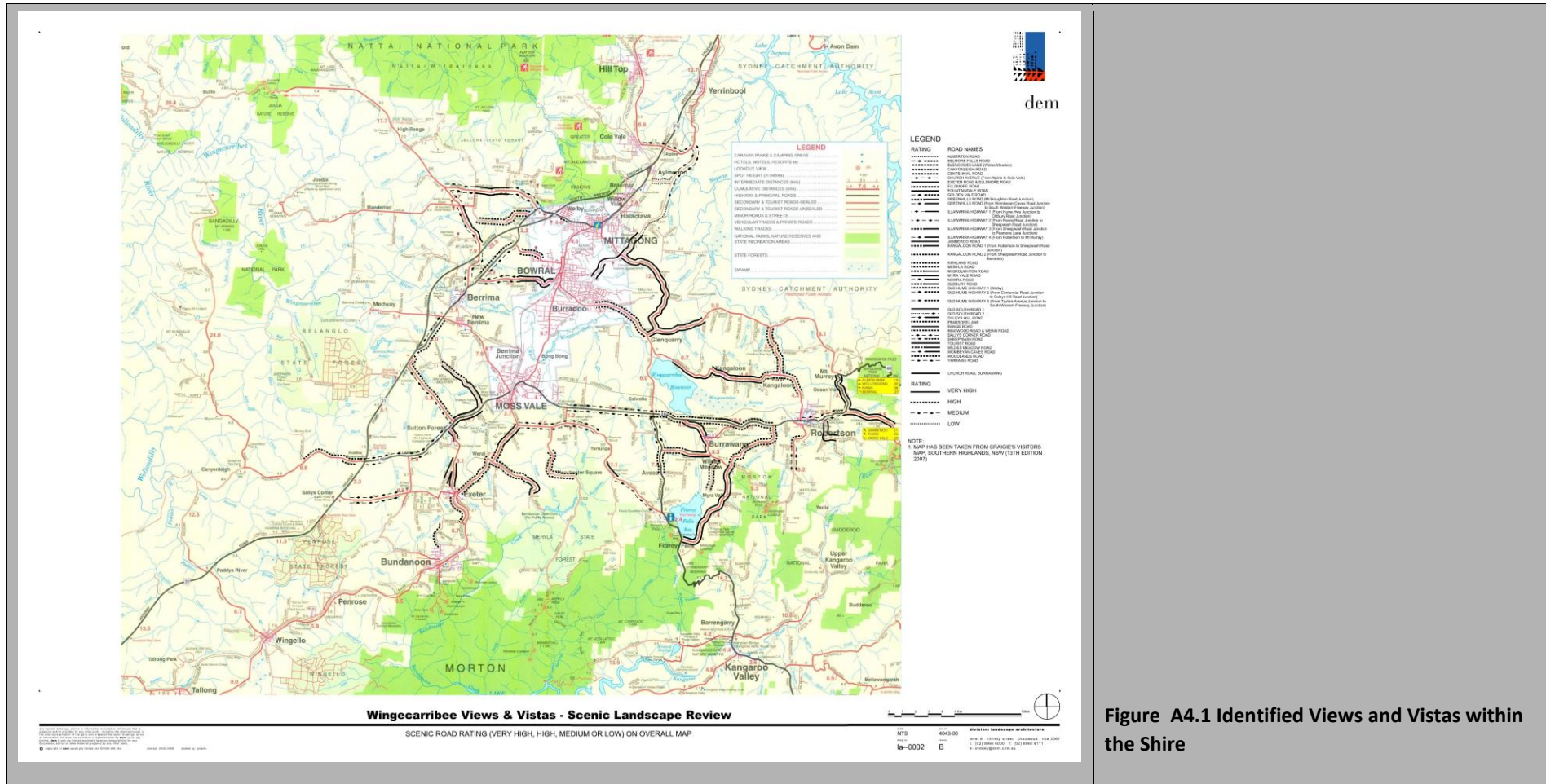

Figure A4.1 Identified Views and Vistas within the Shire



Council now requires that the following objectives and controls relating to such plantings shall be included as part of the Development Application requirements and failure to comply with these controls, either at the time of issuing a Compliance Certificate, or at any later stage, shall be deemed a failure to comply with that Certificate.

Council requires that a fifty (50) metre break in the planting occurs for every fifty (50) metres of such planting, thereby ensuring that plantings occur over only 50% of the frontage boundary. Such plantings shall then be kept within the maximum height of two (2) metres.

Such controls will not generally apply to plantings which are not dense in nature. Council officers are able to advise applicants on appropriate plantings, particularly indigenous species, which provide windbreaks and privacy without breaching Council's controls. Such alternative plantings offer hedging options which are visually attractive and provide excellent wildlife habitat. Generally, in this case, Council will not apply the two (2) metre maximum height controls, provided Council's objectives are met.

A4.3.2 Objectives for Vegetative Barrier Planting, Hedging & Row Planting

In assessing proposals for Vegetative Barrier Planting, Hedging and Row Planting along property frontages as part of a Land Use Application, Council shall be satisfied that such plantings meet the following objectives.

- (a) that there is no loss of visual amenity of the rural landscape,
- (a) that there is no loss of amenity to neighbouring properties,
- (b) that the cumulative impacts of such plantings, both on and off site, are considered.
- (c) that identified significant views and vistas are maintained throughout the rural areas of the Shire.
- (d) that appropriate species are selected.
- (e) that on land containing or adjacent to endangered ecological communities, threatened species, riparian corridors or other environmentally sensitive land, that compatible indigenous plant species be selected.

A4.3.3 Controls for Vegetative Barrier Planting, Hedging & Row Planting

To meet the above objectives, Council will not approve proposed Vegetative Barrier Planting, Hedging and Row Planting plans along front boundaries unless the following controls are met.

- (a) The species and mature height of all such plantings must be stipulated in any land use application.
- (b) The maximum height of plantings along the property frontage shall be two (2) metres, unless otherwise permitted by Council.



- (c) Where the maximum height of two (2) metres is confirmed, regular trimming to maintain that maximum height will be required as part of the development consent. Regular monitoring of this condition will occur.
- (d) Introduced species for Vegetative Barrier Planting, Hedging and Row Planting may be restricted in some areas of the Shire due to their proximity to endangered ecological communities, threatened species, riparian corridors or other environmentally sensitive land.

A4.4 Weed Management

Weeds are classified into two main groups, noxious and environmental.

Noxious weeds – Noxious weeds are those weeds identified under the *Noxious Weeds Act 1993*. The owners of rural properties are legally obliged, under the Act, to remove any noxious weed infestation on their property and to manage that property to ensure that future infestations do not occur, or are dealt with efficiently and effectively if they do. It is critical that all property owners take their responsibilities in this regard very seriously as there is no point in one property owner doing so if neighbouring owners do not. In New South Wales the Noxious Weeds Act is implemented and enforced by Council.

As part of the site assessment process in preparing a Land Use Application, owners must identify any infestations of noxious weeds and take immediate steps to eradicate them. If owners are unfamiliar with weed plants, independent professional advice may be sought, or enquiries made of relevant Council staff.

Environmental weeds - Environmental weeds are plants that represent a threat to the conservation values of natural ecosystems. They invade and out-compete native plant communities causing a reduction in plant diversity and resulting loss of habitat for native animals. Council can supply a list of environmental weeds on request. While Council does not have the authority to require property owners to appropriately manage environmental weeds, it is in the long term interests of the property owner to learn to recognise such weeds and to deal with them in an expeditious manner.

Council's website provides further information on weeds and Council staff can provide advice on alternative plantings. For further information please visit:

<http://www.wsc.nsw.gov.au/services/environment/flora-fauna/noxious-weeds>

A4.4.1 Objectives

In addressing weed management, Council seeks to achieve the following objectives:

- (a) To require the immediate treatment and ongoing management of noxious weeds on the site in order to comply with the requirements of the *Noxious Weeds Act 1993*.
- (b) To minimise the potential for the spread of plantings (being plantings that are associated with a development) to invade native bushland and other areas of environmental significance including National Parks and Nature Reserves.



A4.4.2 Controls

To meet the above objectives, the following controls apply.

- (a) Where a plant that has been declared a noxious weed for the Shire under the *Noxious Weeds Act 1993*, is identified on land that is subject of an application for consent, Council may decline to grant consent to such development unless it is satisfied that adequate provision has been made for the immediate treatment and ongoing management of the noxious weed in accordance with a weed management plan, which includes measures considered satisfactory by the Council to control the weeds within the boundaries of that site.
- (b) Where spraying is used, spraying should be in accordance with the all best management guidelines for the safe use of chemicals.

As a part of the assessment of any development application, an inspection of the subject land will be undertaken by Council's Weeds Officer. If the property is found to have noxious weeds, then a condition of any development approval will be that these weeds shall be thoroughly eradicated before final approval, or in the case of subdivision, the release of the linen plans, shall occur.

A4.5 Landform and Vegetation Modification

In assessing a development application Council will consider the extent to which the applicant intends to modify the natural landform and vegetation cover of the site. Because, in a rural environment, earthworks on one property can have a significant impact on adjoining land owners, Council will seek to ensure that any such modifications are justified in terms of making best use of the site and that any impacts are managed on site. Wherever possible, Council would prefer that development make use of existing landform to minimise the extent of earthworks required.

Applicants are reminded that earthworks not associated with any other development is also a form of land use permissible with consent in the three zones to which this Plan applies and therefore a Development Application needs to be lodged. Please see the relevant clauses below.

A4.5.1 Objectives

When assessing a development proposal, Council shall be satisfied that the following objectives are met with regard to any landform or vegetation modifications.

All new development shall:

- (a) seek to use the existing natural topography of the site.



- (b) not require the clearing of native vegetation or established cultural plantings if this results in an increase in the prominence or visibility of the building from a public place or Heritage Conservation Zone.
- (c) where cut and fill of the area of the building footprint is required, that a limit of 750mm cut and 750mm fill apply.

A4.6 Earth Works

Earth works refers to excavation or filling. All earth works needs to comply with the following controls.

A4.6.1 Controls

- (a) The origin and composition of any fill brought into the rural areas must be documented.
- (b) No contaminated fill, including any building waste fill of unknown origin, must be brought into the Rural Areas.
- (c) No fill containing materials that may cause harm to a site or persons using a site may be brought into the rural areas.
- (d) Any excavation works must take into consideration the following:
 - (i) possible wildlife habitat,
 - (ii) The need and purpose of the excavation
 - (iii) The scenic impact (both on and off site)
 - (iv) Erosion mitigation measures

A4.7 Protection of Trees, Bushland and Vegetation during Construction and Development

A4.7.1 Objectives

- (a) To ensure that any development is designed and sited to provide for the protection of Trees and Bushland through construction and development.
- (b) To ensure that development does not compromise the integrity and viability of existing native vegetation, flora and fauna habitat and riparian zones.
- (c) To ensure that no trees or other vegetation is removed from an Item of Heritage or property within a Landscape or Heritage Conservation Area without the consent of Council.



A4.7.2 Controls

- (a) All works and services associated with construction of rural development (development location, stock piles, rubbish, site sheds services access and egress of all vehicles etc) must be sited to ensure they will have no negative impact on trees, vegetation and bush land that is to be retained on site. This will require these to be located clear of any Tree Protection Zones.
- (b) Best practice methodologies must be employed to maintain Tree Protection Zones. This will include the size of the zone, appropriate fencing/buffering etc
- (c) Best practice methodologies must be employed in the design and installation of any services to the site to ensure the long term viability of trees, vegetation and bush land. This needs to include no interruption to flow paths of surface water.
- (d) Siltation control fences and measures must be provided to protected vegetation trees, bush land and riparian zones.
- (e) No clearing of vegetation on land with slopes of 18 degrees or greater.
- (f) An Arborist or qualified horticultural may be required to supervise works on site to ensure the retention of nominated trees, vegetation or bush land.
- (g) No removal of trees or other vegetation from an Item of Heritage or from a property within a Landscape or Heritage Conservation Area shall occur without the consent of Council under the provisions of Section A4.11 below.

A4.8 Environmental Remediation

Council is committed to the ongoing preservation of the environment. Council may make it a condition some applications to carry out environmental remediation works on site. Council is also committed to the ongoing replanting and remediation works in the Shire. There are many sources of funding and assistance to carry out environmental works on private properties provided by a range of government departments and agencies. Interested persons should contact Council to find out more information about these opportunities.



A4.9 Arborist's Report

Some development applications, including subdivisions or boundary adjustments within the rural areas where there is may be an impact on existing trees or vegetation of significance, may require the preparation of an Arborist's Report by a suitably qualified person.

A4.9.1 Objectives of an Arborist's Report

- (a) To ensure that any development is compatible with the physical constraints and existing character of the area.
- (b) To ensure that any development does not compromise the integrity and viability of existing native vegetation, flora and fauna habitat and riparian zones.

A4.9.2 Issues to be Addressed in an Arborist's Report

- (a) An Arborist's Report must be prepared by a suitably qualified professional.
- (b) The report shall identify those trees which, in the opinion of the arborist, warrant recording and assessment.
- (c) For those trees identified in sub-clause (b) above, the following details shall be provided:-
 - (i) The location of the identified trees.
 - (ii) The species / genus of each tree.
- (d) A Safe Useful Life Expectancy (S.U.L.E) rating for each tree. The trees to be retained on site including the Tree Protection Zone.
- (e) The proposed impact of all aspects of development on each tree (including possible root effects).

A4.10 Roadside Reserves

Because roadside reserves are publicly owned lands, they are subject to the care, control and management of public authorities. The majority of roadside reserves in the Shire are owned and managed by Council. Council has produced the 'Wingecarribee Council Roadside Management Plan' which details the controls that apply to clearing along fencing lines, new plantings, and the placement of access ways from the road on to a rural property in order to ensure the protection of native vegetation. Applicants are advised to consult this document in the planning and implementation of any practices that might impact on roadside areas including the planting or clearing of vegetation.

A4.10.1 Objectives

The Roadside Management Plan seeks to achieve the following objectives.



- (a) To ensure the retention of all native vegetation occurring on roadside reserves
- (b) To ensure that any property access ways are located and constructed to minimise any loss of native vegetation occurring within the road reserve.

A4.10.2 Controls

In order to achieve these objectives, Council requires compliance with the following controls.

- (a) no planting of any species of tree, hedging plant, or shrub is permissible in road reserves owned by public authorities without the consent of Council.
- (b) All property access ways must be located to minimise the loss of any road side vegetation.

A4.11 Preservation of Trees and Other Vegetation

A4.11.1 Objectives

The objectives of this Section of the Plan are to:

- (a) preserve the amenity, biodiversity and ecology of the Rural Lands through the preservation of trees and other vegetation as described in Clause 5.9 of WLEP 2010.
- (b) preserve the amenity and heritage value of trees and other vegetation associated with Items of Heritage or within Heritage Conservation Areas.
- (c) clarify the meaning of Clause 5.9 of WLEP 2010.
- (d) define and explain the terms used in Clause 5.9 of WLEP 2010.
- (e) clarify the assessment criteria under which exemptions will be determined.

A4.11.2 Introduction

Clause 5.9 of Wingecarribee LEP 2010 (WLEP 2010) addresses the preservation of trees or other vegetation. The objective of this clause is to “preserve the amenity of the area, including biodiversity values, through the preservation of trees and other vegetation”.

The elements of the clause and its sub-clauses are addressed in detail below, but in essence, this clause is saying that a person may not ringbark, cut down, top, lop, remove, injure, or wilfully destroy any tree or other vegetation without Council consent. These terms are defined below (A5.1.4) and there are exemptions (A5.15 and A5.16).



A4.11.3 WLEP 2010 Controls

Sub-clause 5.9 (2) of WLEP 2010 explains that the provisions of clause 5.9 operate within the context of definitions and explanations contained within the relevant Development Control Plan, stating:

“This clause applies to species or kinds of trees or other vegetation that are prescribed for the purposes of this clause by a development control plan made by the Council” and notes that “the development control plan may also prescribe the trees and other vegetation to which the clause applies by reference to species, size, location or other manner.”

With reference to these DCP definitions, the following controls apply:

Sub-clause 5.9 (3) of WLEP 2010 applies to all Rural Land *except that which is an Item of Heritage or is located within a Heritage Conservation Area (which is addressed in sub-clause 5.9 (7) below)* which states that:

“A person must not ringbark, cut down, top, lop, remove, injure, or wilfully destroy any tree or other vegetation to which any such development control plan applies without the authority conferred by

- (a) development consent, or
- (b) a permit granted by Council.”

With regard to Items of Heritage or Heritage Conservation Areas, sub-clause 5.9 (7) overrides sub-clause 5.9 (3), stating that:

A permit under this clause cannot allow any ringbarking, cutting down, topping, lopping, removal, injuring or destruction of a tree or other vegetation:

- (a) that is or forms part of a heritage item or that is within a heritage conservation area, or
- (b) that is or forms part of an Aboriginal object or that is within an Aboriginal place of heritage significance,

unless the Council is satisfied that the proposed activity:

- (a) is of a minor nature or is for the maintenance of the heritage item, Aboriginal object, Aboriginal place of heritage significance or heritage conservation area, and
- (b) would not adversely affect the heritage significance of the heritage item, Aboriginal object, Aboriginal place of heritage significance or heritage conservation area.

Exemption from this sub-clause also applies if the development is limited to the removal of a tree or other vegetation that the Council is satisfied is a risk to human life or property.



A4.11.4 Definitions

As explained above, the provisions of clause 5.9 of WLEP 2010 rely on definitions contained within this DCP. Therefore, for the purposes of clause 5.9, the Rural Lands Development Control Plan applies the following definitions:

Tree - means a perennial plant with at least one self supporting stem which,

- (i) has a height of more than 6 (six) metres, and
- (ii) has an outside circumference of at least 500mm at a height of 1 metre above the ground, or,
- (iii) has an outside circumference of at least 500mm measured at ground level where the tree has been cut down or removed, or
- (iv) has a branch and foliage crown spread of at least 4 metres.

Where 'height' means the distance measured vertically between the horizontal plane at the lowest point at the base of a tree which is immediately above ground and the horizontal plane immediately above the uppermost point of a tree.

Other vegetation – associated with an Item of Heritage or within a Heritage Conservation Area - means any plant life not defined by this Plan as a 'tree' and includes, but is not restricted to, any sapling, shrub, scrub, understorey plants, groundcover (being any type of herbaceous vegetation) and plants occurring in a wetland.

Other vegetation – not associated with an Item of Heritage or not within a Heritage Conservation Area – means any plant life not defined by this Plan as a 'tree' which is located:

in the riparian zone associated with a creek, river, watercourse wetland, stream, or other aquatic habitat as delineated in the Natural Resources Sensitivity Maps of the LEP,
within a wildlife corridor as delineated in the Natural Resources Sensitivity Maps of the LEP,
on land owned by Council or under its care, control or management, including road reserves.
or performs an environmental role, as described below:

- (i) provides habitat or likely habitat for threatened species, populations and endangered ecological communities as defined within the Threatened Species Conservation Act, or
- (ii) is koala habitat.

Top or topping - means cutting away part or all of a tree's foliage crown leaving a trunk and stubbed main branches to reduce its height and spread. Council's considers this to be an antiquated practice which damages a tree, reducing strength and vigour and promoting its premature decline.



Lop or lopping - means cutting between branch unions or at internodes on a young tree, with the final cut leaving a stub. This does not include “lopping” where this is solely for the purpose of feeding stock in an officially drought declared area, provided the vegetation’s continued health is not affected. This does not include ‘pruning’ as defined in A5.1.5 below.

Remove, removal and cutting down - mean to dismantle a tree, for example by chainsaw, or to separate the tree from the ground where it is growing or dislodging it with earth moving equipment in order to kill the tree so that the tree, including its branches, foliage, trunk, stump and root system will not regrow. This includes the poisoning of the stump and/or roots and/or taking away, or grinding or burning out of its remains to prevent regrowth.

Destroy - means any immediate or ongoing process or activity leading to the death of a tree.

Injury and wilful destruction - mean damage to a tree and includes:

- (i) lopping and topping;
- (ii) poisoning, including applying herbicides and other plant toxic chemicals to a tree or spilling (including washing off or directing water contaminated by) oil, petroleum, paint, cement, mortar and the like onto the root zone;
- (iii) cutting, tearing, snapping and breaking of branches and roots that is not carried out in accordance with accepted arboricultural practices or is done for invalid reasons such as vandalism;
- (iv) ringbarking, scarring the bark when operating machinery, fixing objects (eg signs) by nails, staples or wire, using tree climbing spikes in healthy trees marked for retention (except for access to an injured tree worker) or fastening materials that circle and significantly restrict the normal vascular function of the trunk or branches or inflicting a blaze on a tree as a marker point;
- (v) damaging a tree’s root zone by compaction or excavation, stripping of topsoils, asphyxiation by burial (including unauthorised filling or stockpiling of materials) or the alteration of ground level or water table which causes damage to the tree or any part of the tree;
- (vi) “underscrubbing”, unless carried out by hand tools.

A4.11.5 The Definition of Pruning

Pruning is not specifically included in the list of activities requiring development consent under clause 5.9(3) of WLEP 2010 and in the past certain lopping activities have not been referred to Council for approval because it has been argued that they are in fact ‘pruning’ rather than ‘lopping’.

However, as every gardener knows, one person’s idea of ‘pruning’ is another’s idea of vandalism. Therefore, in an effort to bring some reason to the issue while still seeking to



protect gardens and landscape trees and vegetation from destruction, the following guidelines are offered and definition prescribed.

The Macquarie Dictionary defines ‘pruning’ as “cutting or lopping superfluous or undesirable twigs, branches or roots from, to trim”. This definition suggests that ‘pruning’ is a form of ‘lopping’, but the difference between the two is a matter of degree and judgement. The terms ‘twigs’, ‘branches’ and ‘trim’ imply ‘modest lopping’, while the terms ‘superfluous’ or ‘undesirable’ imply some professional knowledge of tree structure and growth patterns.

Therefore, for the purposes of this Plan, ‘pruning’ means:

- (i) removing branches or other growth as part of the natural cultivation of the tree or plant, such a pruning roses, hydrangeas, fruit trees and vines, maintaining hedges or mowing of grass, or
- (ii) removing branches or other growth which has suffered storm, wind or similar damage; or
- (iii) removing branches or other growth which is decayed and threatens the viability of the tree, or
- (iv) removing branches or other growth in order to allow a planting up to four (4) metres in height to develop a stronger growth habit, or
- (v) removing branches or other growth from planting greater than four (4) metres in height, which will, in the opinion of a professional arborist, protect or enhance the growth and habit of that planting. That professional opinion shall be obtained in writing and be available for Council perusal if requested.

Council considers that ‘pruning’, as described above, does not constitute ‘lopping’ for the purposes of clause 5.9 (3) or 5.9 (7). Every other form of lopping, even if considered by the gardener to constitute ‘pruning’, shall require a consent from Council if such ‘pruning’ does not meet the definition above.

This definition does not extend to the severe cutting back of trees and other vegetation to the point where they die, or the ripping out of lawn to be replaced with paving or other plant material. Such activity must be approved by Council, in writing, beforehand.

The onus on proving that any ‘pruning’ brought to the attention of Council complies with the above definition shall lie with the property owner. Pruning is most likely to be investigated by Council following the lodging of a complaint and generally applies to the removal of branches from larger or older trees.

Property owners are advised to obtain the services of professional arborist for the removal of significant tree branches in order to satisfy subclause (e) of the above definition. Where pruning under subclauses (b) and (c) is undertaken, a photographic record of the damage would assist the property owner in establishing the bona fides of the pruning activity.

Applicants are also directed to Australian Standard AS4373-2007 – Pruning for Amenity Trees, for further direction on pruning.



A4.11.6 Exemptions

Sub-clauses 5.9 (5) and (6) identify those situations in which the controls of sub-clause (3) do not apply.

Sub-clause (5) - This clause does not apply to a tree or other vegetation that the Council is satisfied is dying or dead and is not required as the habitat of native fauna.

Sub-clause (6) - This clause does not apply to a tree or other vegetation that the Council is satisfied is a risk to human life or property.

These exemptions do not affect Items of Heritage or Heritage Conservation Areas, however sub-clause 5.10 (3) (c) exempts sub-clause 5.9 (7) in the case of the removal of a tree or other vegetation that the Council is satisfied is a risk to human life or property.

In addition to these exemptions, the following exemptions apply. Notwithstanding these exemptions, it is still a requirement that Council be notified (in writing) of all vegetation management works (excluding those which are exempt under the Local Environment Plan) including removal and disturbance to trees and other vegetation and offset planting is required to ensure no net loss within the Shire.

This Section of the DCP does not apply to vegetation management carried out for the following purposes:

- (i) emergency bushfire hazard reduction within the meaning of the Rural Fires Act 1997,
- (ii) compliance with a Bushfire Hazard Reduction Certificate issued within the meaning of the Rural Fires Act 1997, in accordance with the Bushfire Environmental Assessment Code or a Section 66 Notice issued within the meaning of the Rural Fires Act 1997,
- (iii) to maintain an approved bushfire hazard asset protection zone within the meaning of the Planning for Bush Fire Protection guideline,
- (iv) emergency fire fighting, emergency access or emergency works undertaken by a public authority within the meaning of the State Emergency Rescue and Management Act,
- (v) work that a qualified representative from Council is satisfied is necessary to protect a person or property from imminent physical danger attributable to vegetation,
- (vi) work ordinarily incidental to the use, operation and management of a lawful development, the maintenance of garden and landscaped areas, excepting work involving the removal or lopping of a tree, as defined,
- (vii) action required or authorised to be done by or under the Electricity Supply Act 1995, the Roads Act 1993 or the Surveying Act 2002,



- (viii) clearing of native vegetation that is authorised by a development consent or property vegetation plan under to the Native Vegetation Act 2003, or that is otherwise permitted under division 2 or 3 of part 3 of that Act,
- (ix) clearing of vegetation on State protected land (within the meaning of clause 4 of Schedule 3 to the Native Vegetation Act 2003) that is authorised by a development consent under the provisions of the Native Vegetation Conservation Act 1997 as continued in force by that clause,
- (x) compliance with any development approved pursuant to Part 5 of the Environmental Planning and Assessment Act 1979,
- (xi) to protect or maintain existing public utilities (associated with the provision of power lines, transmission of electricity, water, gas, sewer mains, electronic communication or the like),
- (xii) to destroy or remove declared noxious weeds, a current list of which may be obtained from Council,
- (xiii) except in the case of Items of Heritage, or in Heritage Conservation Areas, to destroy or remove declared environmental weeds, a current list of which may be obtained from Council
- (xiv) to transplant field grown trees propagated for sale as advanced specimens growing on land occupied by an approved plant nursery,
- (xv) works on the same land parcel, within three (3) metres of the foundation walls of an approved habitable building or in ground pool,
- (xvi) works on trees or other vegetation within a State Forest or land reserved from sale as a timber reserve under the Forestry Act 1916,
- (xvii) a tree that Council is satisfied is dying or dead and is not required as the habitat of native fauna,
- (xviii) a tree which is identified for removal in a Land Use Approval under the Environmental Planning & Assessment Act 1979.
- (xix) pruning, as defined in A5.1.5 above.

A4.11.7 Assessment Considerations

In assessing applications for Council consent under clause 5.9 of WLEP 2010, Council's considerations will include, but not be limited to, the following:

- (i) Whether the community interest has been taken into account. Priority for preservation will be given to trees which have significant amenity or aesthetic value, are noteworthy in the land or streetscape or from a botanical or heritage viewpoint.



- (ii) Whether the proprietary interest of the applicant has been duly respected. If the proposed work is ordinarily incidental to the use, operation and management of a lawful development or the design and maintenance of a garden it may not be reasonable for such work to be refused approval.
- (iii) Whether the enjoyment of neighbouring land will be detrimentally affected. If so, notice may have to be given to persons owning or occupying adjoining land.
- (iv) Whether replacement planting is proposed. All Council approvals to remove trees or other vegetation shall contain appropriate requirements for offset planting to ensure no net loss of vegetation.
- (v) Implications for biodiversity. It will be essential to determine the conservation status of the tree/vegetation. Priority will be given to trees which are rare or endangered, are ecologically significant in the local or regional context, form part of a naturally occurring remnant, are self-sown from locally indigenous stock or provide habitat for wildlife. It may be necessary for a flora and fauna survey and assessment of ecological values to be carried out. If a survey and assessment have been done they should be reviewed to ensure that they have been adequately completed under appropriate seasonal conditions.
- (vi) Whether there are issues of personal or public safety. There may be potential hazards to people or property in the context of the following. A qualified arborist, engaged by the applicant and at their expense, will be required to determine if there is or may be a danger to life and/or property.
 - (i) The structural soundness of a particular tree,
 - (ii) Genetic or other characteristics and history of a particular species or specimen,
 - (iii) Siting issues such as ground conditions, building proximity, etc.,
 - (iv) Poor health, such as allergies, where specific evidence is provided by an expert in the relevant medical field and a direct causal link between the ailment and the species is reasonably established,
 - (v) Existing (or potential for) vehicular or pedestrian traffic hazard in proximity to a roadway, intersection or driveway, where pruning would be an insufficient remedy.
- (vii) Whether a need is demonstrated for solar access to habitable rooms in buildings, solar appliances, clothes drying and outdoor living areas.
- (viii) Whether there are more practical or desirable alternatives. Pruning may be a better solution or the relocation or redesign of services, fences etc.



- (ix) Whether the proposed work should be carried out and/or supervised by a suitably qualified person.
- (x) Whether the application should more properly be part of a wider development and/or building works. If so, the removal of trees or other vegetation should be included and dealt with as part of a land use application for the wider development.
- (xi) Whether there is a justified need. Provided that no significant hazard or other safety issues also apply the following shall not generally be considered as valid reasons to remove a tree:-
 - (i) The shedding of leaves, bark, sticks, fruit or exudate into gutters, downpipes, pools, onto lawns etc.,
 - (ii) Bird droppings on cars,
 - (iii) To improve street lighting of private property,
 - (iv) To enhance private views,
 - (v) To reduce minor shading,
 - (vi) Minor lifting of driveways and paths by tree roots,
 - (vii) To erect a fence,
 - (viii) Bushfire hazard control which has not been approved by Rural or NSW Fire Brigades,
 - (ix) Potential damage to sewer mains unless supported by written expert advice and only where reasonable alternatives are not feasible (e.g. relocation or encasement of main),
 - (x) Potential wind damage to property. (Note: Trees absorb wind energy as a group during storms and help reduce the impact on houses and other trees and structures. The more trees are removed, the more wind damage is likely to exposed buildings and trees in isolation),
 - (xi) Unsubstantiated fears of large trees.
- (xii) Whether adverse impacts of the proposal have been adequately identified and will be satisfactorily mitigated. Measures will need to address the following matters where appropriate:-
 - (i) Disposal of vegetation. The applicant must undertake not to burn any trees or vegetation removed except in accordance with an approval issued by Council under clause 6G(2) of the Protection of the Environment Operations (Clean Air) Regulation 2002.
 - (ii) Soil erosion or siltation.



- (iii) Protection of retained trees and vegetation.
- (iv) Protection of affected wildlife.
- (v) Ongoing management of offset plantings. A monetary bond may be required for this.
- (vi) Weed invasion.

A4.11.8 Penalties

In the event that a person contravenes or causes or permits to be contravened these controls, Council will consider issuing penalty notices or taking legal action against that person in accordance with the relevant provisions of the Environmental Planning and Assessment Act 1979 and the Environmental Planning and Assessment Regulation 2000.

A4.11.9 Application Form for the Removal of Trees or Other Vegetation

An Application Form may be obtained from Council's website, or from the Customer Services Counter.

A4.11.10 Right of Appeal

An applicant may appeal to Council against a decision made with regard to the removal of a tree or other vegetation. An appeal should be made in writing stating reasons for the objecting and including supporting documentation from a suitably qualified professional. An appeal may also be made to the Land and Environment Court.

A4.11.11 Limitation of Consent

A consent given to remove a tree or other vegetation remains valid for a period of two (2) years from the date on which the consent is given and extends only to work which the applicant is legally entitled to carry out. Such work must be carried out with due regard to all legal rights of other parties.

A4.11.12 Additional Terms used in this Section

Amenity - means that which gives pleasure by being aesthetically attractive, affording comfort, sustaining life and health or creating a sense of well being. This plan seeks to preserve trees and vegetation for their social, recreational, environmental, ecological, scientific and economic benefits. These benefits include:

- the conservation of scenic and heritage landscapes,
- improvement in air and water quality,
- moderation of air temperature,
- reduction in atmospheric pollution,
- mitigation of soil erosion and stormwater runoff,
- improvement in soil permeability,



- stream bank stabilisation,
- absorption of wind energy,
- enhancement of biodiversity and habitat for wildlife
- sequestration of atmospheric carbon and
- energy conservation.

Biodiversity - means the variety of all life forms on earth; it is the different plants, animals and micro-organisms; their genes; and the terrestrial, marine and freshwater ecosystems of which they are a part.

Biodiversity exists at three main levels:

- *genetic diversity*—the variety of genetic information that is contained in all living things and that varies within and between the populations of organisms making up single species or wider groups
- *species diversity*—the variety of species on earth
- *ecosystem diversity*—the variety of the earth's habitats, ecosystems and ecological processes.

Habitat of native fauna - means any tree naturally occurring (being native vegetation or remnant native vegetation) which has developed hollows in the trunk or limbs and which is suitable for nesting birds, arboreal marsupials (such as possums) or native placental mammals (such as bats) or which is supporting the growth of locally indigenous or endemic epiphytic plants (such as orchids).

Dead - means a tree that is no longer capable of performing any of the following processes:

- Photosynthesis via its foliage crown (as indicated by the presence of moist, green or other coloured leaves);
- Osmosis (the ability of the roots system to take up water);
- Turgidity (the ability of the plant to hold moisture in its cells);
- Epicormic shoots (the production of new shoots as a response to stress, generated from buds under the bark or from a lignotuber – at ground or underground stem);

Dying - means a tree that is exhibiting any of the following symptoms

- Permanent leaf loss in both deciduous and evergreen plants;
- Permanent wilting (the loss of turgidity which is marked by drying out of stems, leaves and roots):



- Shedding of the epidermis (bark dries out and peels off to the beginning of the sapwood).

Offset - means an action that ensures that there is a net environmental improvement as a result of development. Offsets may be used in those circumstances where development results in an unavoidable impact to the integrity of natural assets. Offsets refer to the means of compensation for the loss of natural values that results from development. Council may, from time to time adopt an offsetting policy and/or guidelines which the applicant may be referred to in order to achieve offsets.

No net loss - means no overall loss in the total extent, quality, ecological integrity and security of the trees, other vegetation and biodiversity values of the area.

Risk to human life or property - means imminent danger to human life or significant property.



Section 5 Water Management

A5.1 Introduction

Many of the controls in this section derive from WLEP 2010, or are required by state authorities. Failure to comply with these requirements will delay approval of the application and may result in the application being rejected.

A5.1.1 What is Water Quality?

Water is a fundamental requirement for all life. Abundant clean water and healthy aquatic ecosystems are essential for the maintenance of both human and natural systems.

A5.1.2 Why is Water Quality Important?

- (a) Healthy aquatic ecosystems fulfil crucial ecological, chemical and geomorphic functions within a catchment such as maintaining biodiversity, providing essential links in food chains, mitigating flood damage, moderating groundwater changes, and the cycling of nutrients.
- (b) Clean water and healthy aquatic ecosystems provide drinking water for the Shire's residents.
- (c) Healthy aquatic ecosystems contribute significantly to the viability of major industries such as agriculture, and tourism.
- (d) Clean water and healthy aquatic ecosystems are also intrinsically important as the community values healthy water ways in their own right for aesthetic and recreational reasons and for the contribution that they make to our health and wellbeing, and our identity and "sense of place".

A5.1.3 Current Issues relating to Water Quality

- (a) All sub-catchments in the hire are either in a "disturbed" or "degraded" condition.
- (b) The water quality in the Wingecarribee, Wollondilly and parts of the Nattai Rivers consistently exceed ANZECC water guidelines. (See Table Below)



- (c) Many of the Shire's waterways suffer from the introduction of excessive nutrients and are subject to algal blooms (including Blue green Algae) which results in poor water quality.
- (d) Urban and agricultural runoff and sewerage treatment plant discharges continue to have an adverse affect on water quality in the shire.
- (e) Large sections of the Shire have damaged river corridors with much of the native bushland buffers having been removed, along with the stabilising buffer effect that it provides.
- (f) A large percentage of the Shire's water systems and wetlands are on, or run through private property, and therefore water quality relies on the input from many individuals.

Sub catchment	Visual	Eutrophication	Recreational	Drinking Water
Wingecarribee River				
Wollondilly River				
Nattai River				
Upper Nepean River				
Kangaroo River				
Legend to Table – Percentage of samples exceeding relevant ANZECC and ARMCANZ guidelines				
Not Monitored	0-25% outside guideline range	25-50% outside guideline range	50-75% outside guideline range	75-100% outside guideline range

A5.1.4 What can individuals do?

- (a) Protect and manage stormwater discharges from homes, businesses and industry
- (b) Conserve water use wisely at home and at work (through user habits, water saving appliances and flow control devices)
- (c) Enhance vegetation conditions along river corridors which will provide an effective buffer strip to our waterways.



- (d) Control damaging access (eg. stock access) to waterways.

A5.1.5 What could Council do?

- (a) Minimise the impact from Sewerage Treatment Plant discharges by maintaining effective treatment controls, and looking for opportunities to increase the amount of recycling/reuse of treated effluent.
- (b) Undertake catchment protection works in its drinking water supply catchments.
- (c) Look for opportunities to harvest stormwater.
- (d) Introduce more devices that effectively treat and improve stormwater quality, and aim for a wider strategy of “Water Sensitive Urban Design”.
- (e) Have an organised program which aims to monitor, protect and enhance the vegetation condition along river corridors and wetlands which under the care and control by Council.
- (f) Implement programs and policies aimed to conserve and enhance the vegetation condition along river corridors and wetlands that are in private ownership.
- (g) Undertake community engagement / education aimed at improving community habits related to water conservation, stormwater protection, and river protection.
- (h) Install water saving devices at Council facilities.

A5.2 Development within Sydney’s Drinking Water Catchments

A5.2.1 Introduction

The Sydney Catchment Authority (SCA) manages and protects Sydney's drinking water catchments through the regulation of developments in the catchment areas, consistent with the *Drinking Water Catchments Regional Environmental Plan No 1* (the REP), or its equivalent. All development in Wingecarribee Shire must comply with the requirements of the REP.

A5.2.2 Objectives

- (a) To ensure water catchments deliver high quality water while sustaining diverse and prosperous communities;
- (b) To improve water quality in degraded areas where quality is not suitable for the relevant environmental values; and



- (c) To maintain or improve water quality where it is currently suitable for the relevant environmental values.

A5.2.3 Controls

- (a) Under the REP, Council cannot grant development consent unless it is satisfied the development will have a neutral or beneficial effect on water quality. In assessing whether a proposed development has a neutral or beneficial effect on water quality, Council must be satisfied that:
 - (i) the development has no identifiable potential impact on water quality; or
 - (ii) will contain any such impact on the site of the development and prevent it from reaching any watercourse, water body or drainage depression on the site; or
 - (iii) will transfer any such impact outside the site by treatment in a facility to the required standard and disposal approved by the consent authority; and
 - (iv) the development incorporates the SCA's current recommended practices (or equivalent standards and practices) which represent best industry or development practice in terms of maintaining water quality.
- (b) Any proposed development which Council believes does not have a neutral or beneficial effect on water quality must be referred by Council to the SCA, for a decision on concurrence, before development approval can be given. The SCA in granting concurrence may impose conditions to ensure a neutral and beneficial impact on water quality. If the SCA is not satisfied a neutral and beneficial impact on water quality can be achieved, concurrence will be withheld and Council will not be able to approve the development. For information on the REP and the SCA's current recommended practices, applicants should refer to the SCA's website.
- (c) To enable Council and the SCA to assess whether a development will have a neutral or beneficial effect on water quality, all development applications in the drinking water catchments must be accompanied by a *Water Cycle Management Study*. The contents of a Water Cycle Management Study, including the information, reports and modelling required, will vary according to the type of development and the risks it poses to water quality, with more in-depth studies required for developments that pose a higher risk. The SCA has published the *Neutral or Beneficial Effect on Water Quality Assessment Guidelines* to assist councils and applicants (available on the SCA's website



which categorises developments into five modules according to complexity and the risk to water quality, as identified in the table below.

- (d) A *Water Cycle Management Study* accompanying a development application must include the following components:
- (i) Clearly outline the development proposed, including a detailed site plan which includes site constraints
 - (ii) A summary and location of the water quality control measures proposed as part of the development
 - (iii) A statement, based on the information in the *Water Cycle Management Study*, as to whether the development has a neutral or beneficial effect on water quality, consistent with the SCA's *Neutral or Beneficial Effect on Water Quality Assessment Guidelines*.
- (e) In addition, the *Water Cycle Management Study* should contain the following reports or modelling as appropriate, based on the development type.

Development Type	Information required in the <i>Water Cycle Management Study</i>
<p>Minor developments which represent a very low risk to water quality. Limited to very minor alterations and additions to residential houses in <u>sewered</u> areas.</p>	<ul style="list-style-type: none"> › An assessment, consistent with the SCA's <i>Neutral or Beneficial Effect on Water Quality Assessment Guidelines</i>, as to whether the development will have any identifiable potential impact on water quality. › If there are any potential impacts then the development requires the information outlined in Module 1 below.
Module 1	
<p>Less complex developments which represent a minor risk to water quality. These typically include new single dwellings, dual occupancy or secondary dwellings, or alterations and additions to existing dwellings, in sewerred areas.</p>	<ul style="list-style-type: none"> › Modelling using the Small-scale Stormwater Quality Model. › Conceptual erosion and sediment controls to be applied during construction.



Module 2

Less complex developments which represent a medium risk to water quality. These typically include new single dwellings, secondary dwellings, dual occupancies or attached dwellings, or alterations and additions to existing dwellings in unsewered areas.

- › Modelling using the Small-scale Stormwater Quality Model.
- › Conceptual erosion and sediment controls to be applied during construction.
- › On-site Wastewater Management Report.

Module 3

Developments considered to be moderately complex which represent a medium to high risk to water quality. These typically include multi-dwelling housing and small-lot residential subdivisions in sewered areas.

- › Stormwater quality modelling (using either the Small-scale Stormwater Quality Model or the MUSIC stormwater quality model)
- › Conceptual Erosion and Sediment Control Plan or a more detailed conceptual Soil and Water Management Plan

Module 4

Developments considered to be moderately complex which represent a high risk to water quality. These typically include multi-dwelling housing and residential subdivisions in unsewered areas.

- › Stormwater quality modelling (using either the Small-scale Stormwater Quality Model or the MUSIC stormwater quality model).
- › Conceptual Erosion and Sediment Control Plan or a more detailed conceptual Soil and Water Management Plan.
- › On-site Wastewater Management Report.

Module 5

Developments considered to be highly complex or non-standard developments which represent the highest risk to water quality. These typically include major industrial and commercial developments, and agriculture developments such as intensive livestock and intensive plant agriculture, extractive industries and tourism and recreational developments.

- › Stormwater quality modelling (using either the Small-scale Stormwater Quality Model or the MUSIC stormwater quality model).
- › Conceptual Soil and Water Management Plan.
- › On-site Wastewater Management Report (if relevant).
- › Development-specific pollutant assessment requirements.



- (f) Applicants and consultants are strongly recommended to refer to the SCA publication, *Developments in Sydney's drinking water catchments – water quality information requirements* (available on the SCA's website). This publication outlines in detail the content requirements for a Water Cycle Management Study, and the different reports and modelling which need to be included, according to the type and scale of development proposed.

A5.3 Water Sensitive Design

A5.3.1 Introduction

Water Sensitive Design (WSD) is a commitment to the avoidance, reduction and recycling of water within developed areas thereby reducing reliance on aquifer ecosystems, wetlands, creeks and rivers, to gain water supply and to discharge wastewater.

Development can have many impacts on the environment, both visible and unforeseen. One typical consequence includes an increase in the discharge (quantity) and frequency of water runoff and nuisance flood events within developed environments. These events largely result from the presence of hard, impervious surfaces e.g. roofs, roads and driveways facilitating runoff across a high proportion of the developed environment. These surfaces reduce the capacity of the environment to absorb and infiltrate water and hence increase reliance on stormwater pipes, creeks and rivers, and flood mitigation structures.

WSD, at both a local and catchment level, assists in reducing these dependences and recharges water back into the environment.

In order to address WSD for development within the Shire, a 'treatment train' approach is recommended. A WSD Treatment Train includes a number of measures and treatments in series, rather than employing one single measure or treatment in order to achieve the objectives of water sensitive design.

An example of a treatment train at a street scale for a proposed subdivision resulting in a small number of new allotments may include:

- ~ Grassed swales adjacent to road/s,
- ~ Onsite bio-retention system and associated gross pollutant trap to capture runoff and filter pollutants and discharge water into natural system at a rate similar to that pre-development, and



- ~ Bio-retention system filtering water discharge from any onsite car park.

A5.3.2 Objectives

The overall aim of WSD is to avoid, or at least minimise, the impact of development on all aspects of the natural water cycle.

WSD objectives for all development proposed within the shire are:

- (a) Conservation of potable water.
- (b) Protection of natural ecosystems and waterways.
- (c) Protection of water quality entering natural ecosystems and waterways.
- (d) Minimisation of surface runoff entering natural ecosystems and waterways.
- (e) Integration of stormwater and wastewater treatments into the natural landscape to enhance visual, social, cultural and ecological values.

A5.3.3 Controls

WSD controls are to be satisfied for all development applications and integrated into the Water Cycle Management Study (or equivalent plan) for the proposed development and included in all modelling conducted (e.g. MUSIC or small-scale stormwater quality modelling).

Objective 1: Conservation of potable water

Controls:

1. All development within the shire is to utilise potable water efficiently. For residential dwellings including houses and units, the requirements of BASIX ensures the development complies with NSW planning requirements to conserve water. For all other development within the shire, the following must be achieved:
 - (a) Minimum 3A* star rated shower heads, tap fittings and toilet flush systems.
 - (b) Installation of rainwater tank/s to be utilised on site for watering of landscaping and may be plumbed to toilets and/ or laundry facilities. Size of tank will vary in accordance with development type and capacity to utilise water onsite. Rainwater tanks should be sized to capture (at minimum) the first 10mm of rainfall runoff from all building roofs proposed onsite.



**3A star rating means a fixture or appliance is rated to that level of water efficiency in accordance with AS/NZS 6400:2005 Water efficient products rating and labelling.*

Objective 2: Protection of natural ecosystems and waterways

Controls:

2. Development should not occur within riparian buffer zones outlined in Wingecarribee Shire Council Local Environment Plan 2010 (Clause 7.5 Natural Resource Sensitivity – Water and related maps) and vegetation within the riparian buffer distances is to be maintained and intact.

Objective 3: Protection of water quality entering natural ecosystems and waterways

Controls:

3. All development within the shire must comply with the requirements of *SEPP (Drinking Water Catchment) 2011* to ensure water quality exiting a site post development achieves a neutral or beneficial effect (NorBE) in comparison to pre-development water quality runoff.
4. Development which proposes to re-develop an existing, developed site (particularly those used previously for commercial and/ or industrial purposes), the proposed development must comply with one of the following, whichever provides the greatest treatment of water:
 - (a) Water quality exiting a site post-development must achieve a neutral or beneficial effect (NorBE) in comparison to pre-development water quality runoff (in accordance with *SEPP (Sydney Drinking Water Catchment) 2011*.
 - (b) Post-development water quality runoff must achieve the following targets as improvements to the pre-development water quality runoff exiting the site:
 - i. 85% reduction in the average annual total suspended solids loads.
 - ii. 65% reduction in the average annual total phosphorus load.
 - iii. 45% reduction in the average annual total nitrogen load.
 - iv. 90% reduction in the average annual gross pollutant (size >5mm) load.
 - v. To retain sediment coarser than 0.125mm for flows up to 25% of the 1 year ARI peak flow.



- vi. To ensure no visible oils for flows up to 25% of the 1 year ARI peak flow, in areas with concentrated hydrocarbon deposition.

(Source: Draft Environmental Targets *DECCW Managing Urban Stormwater*, in Coffs Harbour City Council *Water Sensitive Urban Design Policy*)

It is the responsibility of the developer to meet the objectives which achieve a net positive environmental outcome.

Objective 4: Minimisation of surface runoff entering natural ecosystems and waterways

Controls:

5. For development within the shire which proposes to subdivide land and create four or more allotments, the maximum discharge for the 1:100 year storm shall not exceed the pre-development discharge.

Objective 5: Integration of stormwater and wastewater treatments into the natural landscape to enhance visual, social, cultural and ecological values

Controls:

6. Development must not propose to pipe or channel riparian corridors or waterways.
7. Current recommended practices outlined within *SEPP (Sydney Drinking Water Catchment) 2011* and current best practice technical guides must be utilised to ensure effective functioning of treatment options utilised.

When planning and designing development within the Shire, reference is to be made to Current Recommended Practices contained within *SEPP (Sydney Drinking Water Catchment) 2011* and current best practice guidelines and technical documents such as:

- *Technical Guides: Australian Runoff Quality – A Guide to Water Sensitive Urban Design (Engineers Australia, 2006).*
- *Water Sensitive Urban Design Engineering Procedures: Stormwater (Melbourne Water, 2005).*
- *Water Sensitive Urban Design (Landcom, 2009).*



A5.3.4 Examples of WSD Treatment Options

In order to achieve WSD targets 2 - 5, development will require the use of treatments in series, complementing one another. Table 1 provides examples of suitable WSD treatment options to assist in achieving these targets.

Table 1: Examples of suitable WSD treatment for various development scale

WSUD treatment option	Allotment scale	Street Scale	Catchment/ sub catchment scale
Rain garden	x	x	x
Rain water tank	x	x	
Swales/ buffer strips		x	
Porous paving	x	x	x
Infiltration systems	x	x	
Bioretention basins	x	x	x
Constructed wetlands		x	x
End of pipe treatment e.g. gross pollutant traps	x	x	x

- **Rain Gardens (small bioretention systems)**

Rain gardens are landscaping features which can be incorporated at a range of locations, shapes or sizes, and capture and filter stormwater runoff. They may also include a drainage component conveying flow into the stormwater pipe network beneath. Common locations include small parks, car parking facilities (between parking bays) and surrounding residential dwellings.



Photo*: Example of rain garden (bioretention basin) adjacent to car parking bay at Beachside Car park (Melbourne), Victoria.

- **Swales and Buffer Strips**

Swales and buffer strips act as biofilters slowly conveying water through a filtration medium e.g. grass, vegetation, gravel and disconnect impervious areas (e.g. roads) from downstream waterways. Swales and buffer strips act to collect stormwater runoff and decrease flows and thereby downstream impacts in rainfall events.

They can be used adjacent to roads however should not be used as infiltration points due to the ability of collected water to affect road base materials. Council prefers swales and buffer strips to be located adjacent to roads and not to be included in the medium-stripe design due to access and maintenance issues associated with these locations.



Photo*: Vegetated swale, Fairfield New South Wales



Photo*: Grassed swale with adjacent driveways, Cairlea, Brisbane Queensland.

- **Porous Pavements**

Porous paving (permeable paving) allows rainwater to penetrate into soil and subsoil layers, recharging water supplies and filtering pollutants. In some cases excess water from rainfall events may also be conveyed into drainage pipes located beneath.



Photo*: Porous pavements and permeable street tree plantings located at Sydney Olympic Park, New South Wales.

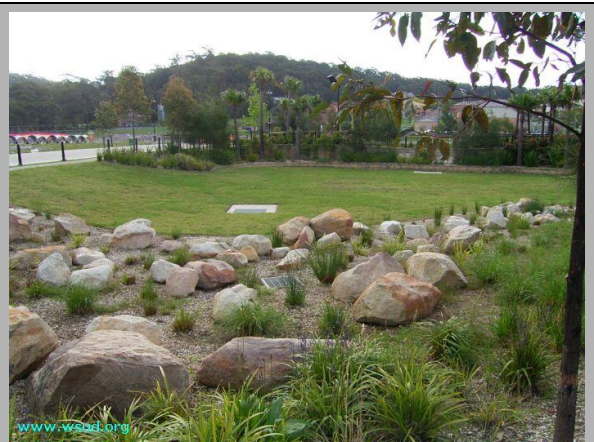

Photo*: Onsite retention basin and vegetated filter integrated into the surrounding landscape, Warriewood (Pittwater Council), Sydney.

- **Infiltration systems**

These systems do not treat stormwater, instead aim to capture runoff and promote infiltration. Infiltration systems reduce damage downstream from heavily rainfall events by reducing peak flows and downstream flooding. These systems also assist in recharging groundwater.

- **Bio-retention Systems**

Bio-retention systems (e.g. basins and swales) are not designed to convey the flow of water, instead they are designed to capture stormwater runoff which drains through a filter medium. Bio-retention basins may take a variety of shapes and forms within a catchment, however they are sensitive to materials which may block them.



Photo*: Vegetated bioretention swale at Warriewood (Pittwater Council), Sydney.

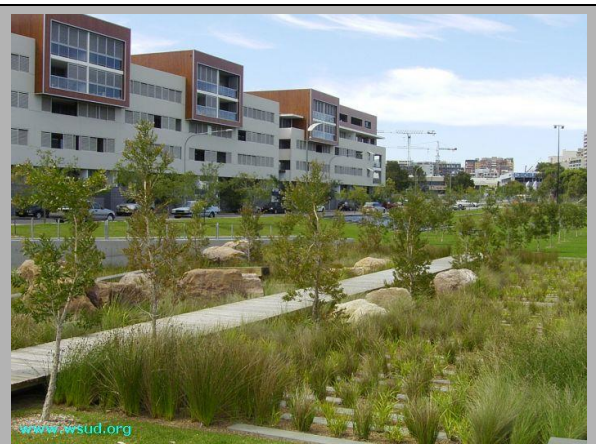

Photo*: Bioretention basin, Victoria Park, Sydney.

- **Constructed Wetlands**

Constructed wetlands are shallow vegetated water bodies which remove pollutants from stormwater through processes including sedimentation, fine filtration, detention and biological uptake. Wetlands can also have significant social and community benefits, providing habitat for wildlife and sites for recreational activities such as walking and bicycle riding. The constructed wetland may be located on-stream or off-stream and will vary in size depending on their location within a catchment.



Photo*: Constructed wetland, Marrickville (Tempe), New South Wales.



Photo*: Constructed wetland, Sydney University (Darlington), New South Wales

- **End of pipe treatments e.g. gross pollutant traps**

End of pipe treatments are designed to be a last resort to capture gross pollution within catchments prior to it entering creeks and waterways. These devices are designed to retain litter and debris, and coarse materials delivered downstream throughout storm and heavy rain events.

End of pipe treatments are used as a last attempt to remove pollution from waterways and require frequent maintenance and cleaning out.





Photo: Gross pollutant trap at Umina, Gosford City Council, New South Wales

(Source: www.gosford.nsw.gov.au).

* Photo source www.wsud.org

A5.4 On-site Waste Water Disposal (OSWD) systems

On-site Waste Water Disposal Plans and their specified systems on unsewered land must meet or exceed the Neutral or Beneficial Effect (NorBE) test and the water quality objectives contained in the Drinking Water Catchment Regional Environmental Plan No1. Council staff can provide further assistance in this regard.

A5.5 Stormwater Management Plans

All Stormwater Management Plans requested by Council or the Sydney Catchment Authority must meet or exceed the Neutral or Beneficial Effect (NorBE) test and the water quality objectives using current Recommended Practices (CPR) contained in the Drinking Water Catchment Regional Environmental Plan No1.

Reference will also be required to the Landcom publication: *Managing Urban Stormwater: Soils and Construction Vol 1, 4th Edition, Landcom, 2004*

A5.6 Erosion and Sediment Control Plans

Where building or earthworks are proposed, Council may request an Erosion and Sediment Control (E&SC) Plan. All E&SC Plans and all associated works must meet or exceed the Neutral or Beneficial Effect (NorBE) test and the water quality objectives using Current Recommended Practices contained in the Drinking Water Catchment Regional Environmental Plan No1.

Reference will also be required to the Landcom publication: *Managing Urban Stormwater: Soils and Construction Vol 1, 4th Edition, Landcom, 2004*



A5.7 Protection of Watercourses, Water bodies and Riparian Lands

A5.7.1 Introduction

Preserving and maintaining natural water bodies and riparian lands is an important element in protecting and enhancing the biodiversity of the Shire and clause 7.4 of WLEP 2010 addresses objectives and controls for the protection, enhancement and management of the ecological, scientific, cultural and aesthetic values of regional wildlife habitat corridors, natural water bodies and riparian land within the Shire. This clause applies to land identified on the Natural Resources Sensitivity Map as regional wildlife habitat corridor, or natural water bodies and riparian land.

The extent of the riparian land corridor required depends on the classification of the associated water body:

A5.7.2 Category 1 – Environmental Corridor

Category 1, marked red on the WLEP 2010 Natural Resources Sensitivity Map, requires a riparian corridor of 50m from the top of bank.

The purpose of this waterway classification is to protect and enhance ecological connectivity between key remnant native vegetation within and between catchments and achieving all four key objectives for riparian corridors. This objective is achieved by multiple management outcomes (that recognise the key management zones) including the provision of a 40m wide core riparian zone (CRZ) each side (measured from top of bank), 10m vegetated buffer (VB) to the CRZ's outer edge and a bushfire asset protection zone (APZ) between the outer edge of the VB and development.

Figure A5.1 below provides an indicative cross-section illustration of a Category 1 - Environmental Corridor – water course.

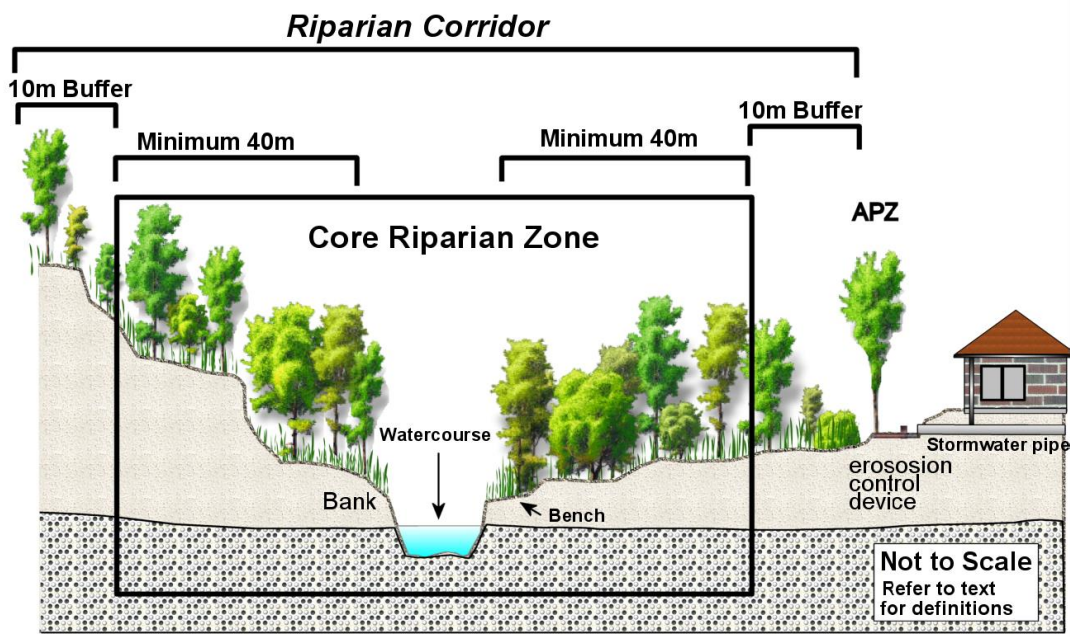

Figure A 5.1 Category 1 – Environmental Corridor

A5.7.3 Category 2 - Terrestrial and Aquatic Habitat

Category 2, marked blue on the WLEP 2010 Natural Resources Sensitivity Map, requires a riparian corridor of 30m from the top of bank.

The purpose of this category is to provide for a viable and robust node or reach of riparian habitat (both aquatic and terrestrial). This habitat does not necessarily provide connectivity to other key remnant native vegetation due to constraints from existing development. This objective is achieved by fewer management outcomes and draws upon a 20m wide CRZ (measured from top of bank, 10m VB to the CRZ's outer edge and bushfire APZ between the outer edge of the VB and development).

Figure A5.2 provides an indicative cross-section illustration of a Category 2 –Terrestrial and Aquatic Habitat – water course.

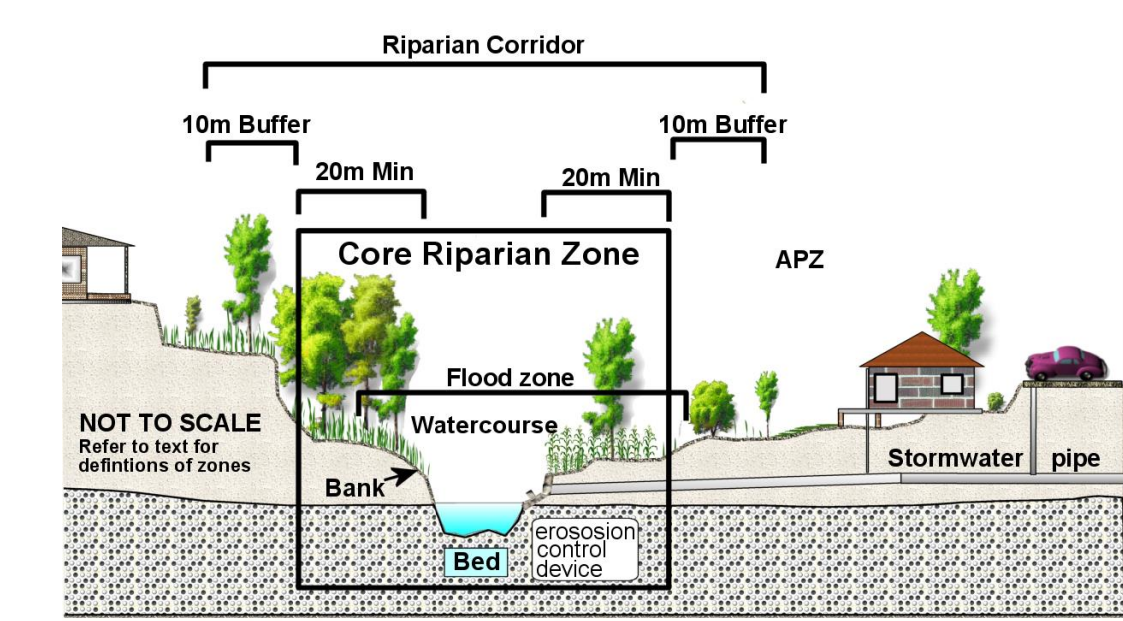

Figure A5.2 Category 2 – Terrestrial and Aquatic Habitat

A5.7.4 Category 3 - Bank Stability and Water Quality

Category 3, marked green on the WLEP 2010 Natural Resources Sensitivity Map, requires a riparian corridor of 10m from the top of bank.

This Category recognises the critical role of riparian vegetation for stabilising the bed and banks of watercourses and filtering catchment run-off and the contribution this makes to overall catchment health and retention of land (eg protection of property and assets).

Figure A5.3 provides an indicative cross-section illustration of a Category 3 –Bank Stability and Water Quality - water course.

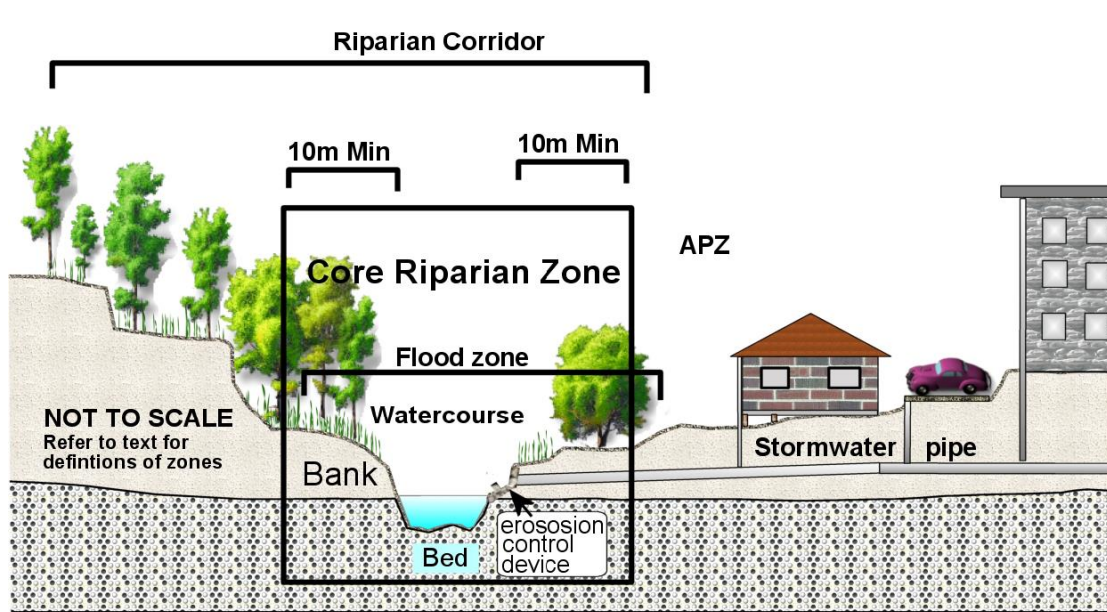

Figure A5.3 Category 3 – Bank Stability and Water Quality

A5.7.5 Objectives

The purpose of providing controls for the protection of watercourses, waterbodies and riparian lands is to:

- (a) ensure that proposed development in or adjoining natural water bodies and riparian land takes into account impacts on the environment including natural water bodies, riparian lands and all associated habitats.
- (b) protect and enhance water quality and aquatic ecosystems, including natural wetlands maintain and, where possible, enhance the ecological and water quality functions of riparian vegetation (both instream and beside stream)
- (c) protect, restore and maintain ecological processes, natural systems and biodiversity within wetlands and waterways.
- (d) provide stream bed and bank stability, protect water quality, maintain viability of riparian vegetation and provide continuity and connectivity for riparian habitat (both instream and beside stream)
- (e) maintain the relative stability of the bed and banks of natural water bodies and riparian land; to minimise sedimentation and pollution of wetlands and waterways and riparian lands.



- (f) protect the scenic and cultural heritage values of natural water bodies and riparian land, to restore degraded wetlands, wetland buffer areas, waterways and riparian zones.

A5.7.6 Controls

In meeting the above objectives, Council requires applicants to comply with the following controls.

- (a) All development in the rural areas shall comply with the riparian zone requirements compiled by the Department of Water and Energy.
- (b) All proposed developments located within or adjacent to aquatic habitats shall comply with the Department of Primary Industries "Policy and Guidelines – Aquatic Habitat Management and Fish Conservation 1999, available online from NSW Fisheries.
- (c) Many developments within or adjacent to natural waterbodies and riparian land (waterways) such as rivers, creeks, wetlands and lakes are subject to the provisions of the Fisheries Management Act 1994. The Act may apply regardless of whether development consent from Council is required or has been granted. Penalties may apply for breaching provisions of the Act. Applicants are strongly advised to contact the Department of Primary Industries for advice before undertaking any development work in these areas.
- (d) Applicants shall take into account if a natural waterbody and riparian land has been nominated by the Department of Primary Industries as a "Fish Migration Route" or "Key Fish Habitat". In such instances developments shall not obstruct the free passage of fish.
- (e) If land adjoining riparian land is to be utilised for extensive livestock agriculture, riparian corridors must be fenced to ensure stock cannot gain access to the riparian land.
- (f) As a part of a land use application for land adjoining or in close proximity to known riparian land, a system of replanting and/or revegetation with native species endemic to the region is to be undertaken in consultation with relevant Council staff.
- (g) Council may impose riparian corridor development standards as a part of a land use application, even if the land subject to the land use application is not within the riparian corridor or classed as riparian lands. This is to ensure that the repair, protection and management of these areas are undertaken where ever possible.



Management Requirements and Minimum Environmental Objectives for Riparian Land are summarized in [Figure A5.4](#) below.

Management Requirements and Minimum Environmental Objectives for Riparian Land	Category 1	Category 2	Category 3
	Environmental Corridor - (marked red on the WLEP 2010 Natural Resources Sensitivity Map)	Terrestrial and Aquatic Habitat - (marked blue on the WLEP 2010 Natural Resources Sensitivity Map)	Bank Stability and Water Quality - (marked green on the WLEP 2010 Natural Resources Sensitivity Map)
Provide a minimum Core Riparian Zone (CRZ) width	40 metres from top of bank	20 metres from top of bank	Usually 10 metres from top of bank
Provide additional width to counter edge effects on the urban interface (i.e. Vegetated Buffer) (VB)	10 metres	10 metres	Generally not required
Provide continuity for movement of terrestrial and aquatic habitat	Yes (including pierced crossings)	Yes (with appropriate crossing design)	Where appropriate
Rehabilitate/re-establish local provenance native vegetation	Yes	Yes	Where appropriate
Locate services outside the CRZ wherever possible	Yes	Yes	Merit consideration
Locate playing fields and recreational activities outside CRZ	Yes	Yes	Merit consideration
Treat stormwater runoff before discharge into riparian zone or the watercourse	Yes (Outside CRZ and buffer)	Yes (Outside CRZ and buffer)	Yes



Vegetated riparian outcomes to be included in Flood Plain Management Assessment	Yes	Yes	Yes
Any bushfire Asset Protection Zone to be measured from the edge of the VB.	Yes	Yes	Where appropriate

Figure A5.4 Management Requirements & Minimum Objectives for each Category of Riparian Land

A5.8 Water Storage Facilities

A5.8.1 Introduction

Under WLEP 2010, Water Storage Facilities are permissible with consent in the three zones to which this Plan applies. 'Water storage facility' means 'a dam, weir or reservoir for the collection and storage of water, and includes associated monitoring or gauging equipment'.

Council may be required to consult with state government authorities including the Department of Water and Energy, in order to confirm their permissibility, placement, size and construction (including materials used for any surrounds). Some facilities may need to provide a fish passage.

Strict guidelines exist for calculating harvestable rights and the correct placement of farm dams. Further information can be sourced through the Department of Water and Energy (Compliance and Licensing Division) and the Catchment Management Authority. A series of fact sheets and best practice guidelines has been produced on farms dams by the [then] Department of Natural Resources. Applicants must consult these departments and documents prior to the construction of any farm dam.

A5.8.2 Objectives

In assessing an application for a water storage facility, Council shall have due regard to the following objectives:

- (a) Ensure that the Water Storage Facility complies with all relevant state government and local government criteria.
- (b) Ensure that the Water Storage Facility does not negatively impact on the environment and associated ecosystems, both on and off site.



- (c) Ensure that the Water Storage Facility does not negatively impact on the visual impact of the rural landscape.

A5.8.3 Controls

To meet the above objectives Council shall require development to comply with the following controls.

- (a) All Water Storage Facilities shall obtain relevant state and local government licenses and / or approvals.
- (b) Applications should address all relevant site planning and environmental controls detailed within this DCP.
- (c) Applications should include a detailed site plan showing the location of the proposed facility in relation to all water courses, gradient and overland run off catchments.
- (d) Details of expected volume in the facility, potential contaminants, sediment and erosion control and location of any associated equipment shall be provided in the application.
- (e) All Water Storage Facilities shall be constructed utilising the relevant best practice methodologies.
- (f) No recycled building products or building waste shall be used in the construction of Water Storage Facilities and associated hard stand areas.

A5.9 Flood Liable Land

A5.9.1 Introduction

In areas close to natural watercourses and riparian land there is an increased risk of flooding. Therefore, these areas may be considered potentially flood liable.

Council does not have flood risk mapping available for rural areas of the Shire, therefore it is the applicant's responsibility to provide evidence of the relevant flood risk category for their development in potentially flood liable areas. This section provides detail of the various flood risk categories.

This sub-section applies to any development for which consent is required that is located on land that can be affected by flooding (referred to as flood liable or flood prone land).

In 1984, the State Government introduced its Flood Prone Land Policy, applicable to all land in New South Wales. The first Floodplain Development Manual (FDM) was published in 1986,



providing guidelines for the implementation of the government's Flood Prone Land Policy and the 'merit approach' that underpins its application.

In 2005, the State Government released revised guidelines under the Floodplain Development Manual (FDM April 2005) to support the Flood Prone Land Policy, the primary objective of which is:

"to reduce the impact of flooding and flood liability on individual owners and occupiers of flood prone property, and to reduce private and public losses resulting from floods, utilising ecologically positive methods wherever possible."

Local Government is the primary authority responsible for both flood risk management and land use planning in New South Wales. The State Government's flood policy provides for a flexible merit based approach to be followed by local government when preparing controls for planning, development and building matters on flood liable land.

The purpose of this section of the DCP is to guide development to ensure risk to life and property associated with flooding is minimised in a manner consistent with the Policies of Council formulated under the NSW Flood Policy and Floodplain Development Manual.

Prior to determining appropriate development controls and understanding potential flood impacts and risks, it is essential that a flood study be prepared for potential flood liable land, if required, where Council does not have such information.

A5.9.2 Objectives

The objectives of this sub-section are to:

- (a) Increase public awareness of the hazard and extent of land affected by all potential floods, including floods greater than the 100 year average recurrence interval (ARI) flood and to ensure essential services and land uses are planned in recognition of all potential floods.
- (b) Inform the community of Council's policy for the use and development of flood prone land.
- (c) Manage the risk to human life and damage to property caused by flooding through controlling development on land affected by potential floods.
- (d) Provide detailed controls for the assessment of applications lodged in accordance with the Environmental Planning and Assessment Act 1979 on land affected by potential floods.



A5.9.3 How to Determine Compliance

Different controls apply to different land uses, depending on the flood hazard applying to the land. The controls in this part of the DCP comprise:

- (a) **The objectives** - a statement of the purpose intended to be achieved by each control, to assist in understanding the control.
- (b) **The performance criteria** - state a desired outcome and a means of assessing whether the desired outcome will be achieved.
- (c) **The prescriptive controls** - preferred ways of achieving the desired outcome. While adherence to the prescriptive controls may be important, it is paramount that the objectives and the performance criteria are clearly satisfied.

A5.9.4 Flood Risk Precincts

The relevant FRP's for Robertson includes that portion of flood prone land potentially affected by the probable maximum flood and described as:

1. High Flood Risk Precinct
2. Medium Flood Risk Precinct
3. Fringe-Low Flood Risk Precinct
4. Low Flood Risk Precinct

Where the following meanings apply:

The **High Flood Risk Precinct** contains that land below the 100 year flood that is either subject to a high hydraulic hazard or where there are significant evacuation difficulties. The high flood risk precinct is where high flood damages, potential risk to life, and evacuation problems would be anticipated or development would significantly and adversely effect flood behaviour. Most development should be restricted in this precinct. In this precinct, there would be a significant risk of flood damages without compliance with flood related building and planning controls.

The **Medium Flood Risk Precinct** contains that land below the 100 year flood that is not subject to a high hydraulic hazard and where there are no significant evacuation difficulties. In this precinct there would still be a significant risk of flood damage, but these damages can be minimised by the application of appropriate development controls.

The **Fringe-Low Flood Risk Precinct** contains that land between the extents of the 100 year flood and the 100 year flood plus 0.5m in elevation (being a freeboard). In this precinct

there would still be a significant risk of flood damage, but these damages can be minimised by the application of appropriate development controls.

The **Low Flood Risk Precinct** contains that land within the floodplain (i.e. within the extent of the probable maximum flood) but not identified within any of the above Flood Risk Precincts.

Hydraulic Hazard is determined as per the definitions contained in the NSW Government “Floodplain Development Manual”. Refer to [Figure A5.1](#) below.

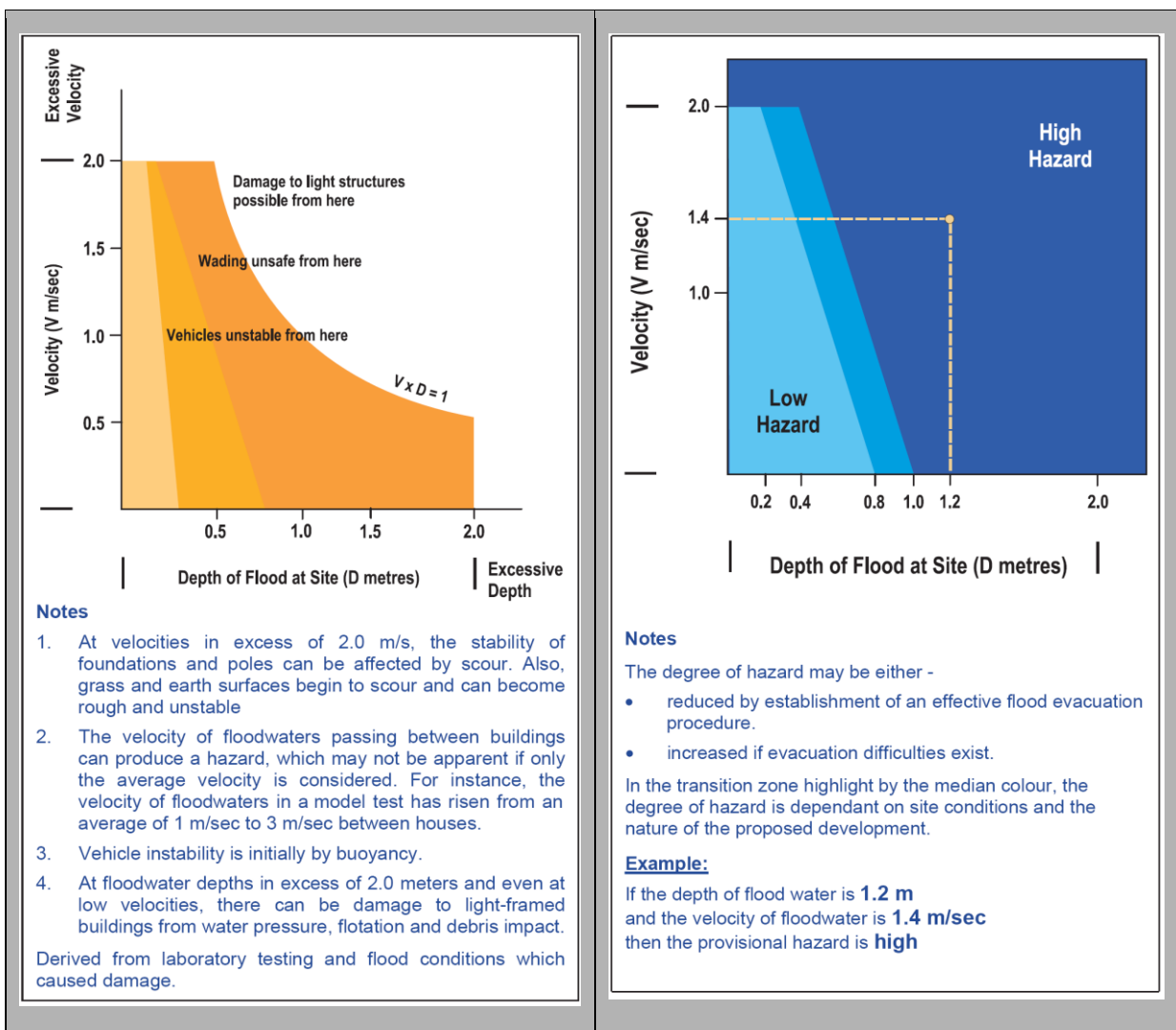

Figure A5.1 Velocity & Depth Relationships (at left) and Provisional Hydraulic Hazard Categories (at right)



A5.9.5 Land Use Categories

The land use definitions contained within WLEP 2010 which are permissible within the RU1, RU2 and E3 zoned, or which may already be located in these zones even if no longer permissible under WLEP 2010, have been grouped into major land use categories based on their sensitivity to flood risks. The eight land use categories and the identified land uses they contain are shown overleaf:

Category	Included Land Uses
Critical uses and facilities	Administration building or public administration building that may provide an important contribution to the notification or evacuation of the community during flood events (e.g. SES Headquarters, Hospitals and Police Stations).
Sensitive uses and facilities	Community facility; Public utility undertaking (including electricity generating works and utility installations) which is essential to evacuation during periods of flood or if affected would unreasonably affect the ability of the community to return to normal activities after flood events; Seniors housing.
Residential	home-based child care centre; home business; home industry; home occupation; residential accommodation; tourist and visitor accommodation.
Commercial or Community	community facility (other than critical and sensitive uses and facilities); place of public worship.
Recreation and Rural	Animal boarding or training establishment; environmental facility; environmental protection works; extensive agriculture; extractive industry; information and education facility; horticulture; landscape and garden supplies; recreation area; recreational facility (outdoor); research station; utility installations (other than critical uses and facilities); and water storage facility.
Concessional development (minor alterations or	(a) In the case of residential development: (i) an addition or alteration to an existing dwelling of not more than 10% or 30m ² (whichever is the lesser) of the habitable floor area which existed at the date of commencement of this



<p>additions)</p>	<p>Plan;</p> <ul style="list-style-type: none"> (ii) the construction of an outbuilding with a maximum floor area of 20m²; or (iii) rebuilt dwellings which substantially reduce the extent of flood affectation to the existing building. <p>(b) In the case of other development:</p> <ul style="list-style-type: none"> (i) an addition to existing buildings of not more than additional 100m² or 10% of the floor area which existed at the date of commencement of this DCP (whichever is the lesser); (ii) rebuilding of a development which substantially reduces the extent of flood risks to the existing development; (iii) a change of use which does not increase flood risk having regard to property damage and personal safety; or (iv) subdivision that does not involve the creation of new allotments with potential for further development.
--------------------------	--

The allocation of land uses among the flood risk precincts is summarised below.



Prescriptive Controls

Planning Consideration	Flood Risk Precincts (FRP's)																								
	Low Flood Risk					Fringe-Low Flood Risk					Medium Flood Risk					High Flood Risk									
	Critical Uses & Facilities	Sensitive Uses & Facilities	Residential	Commercial & Industrial	Recreation & Non-Urban	Concessional Development	Critical Uses & Facilities	Sensitive Uses & Facilities	Residential	Commercial & Industrial	Recreation & Non-Urban	Concessional Development	Critical Uses & Facilities	Sensitive Uses & Facilities	Residential	Commercial & Industrial	Recreation & Non-Urban	Concessional Development	Critical Uses & Facilities	Sensitive Uses & Facilities	Residential	Commercial & Industrial	Recreation & Non-Urban	Concessional Development	
Floor Level		3						3	2,6,7	5,6,7	1,6	4,7			2,6,7	5,6,7	1	4,7						1	4,7
Building Components		2						2	1	1	1	1			1	1	1	1						1	1
Structural Soundness		3						3	2	2	2	2			2	2	2	2						1	1
Flood Effects		2						2	2	2	2	2			2	2	2	2						1	1
Car Parking & Driveway Access		1,3,5,6,7						1,3,5,6,7	1,3,5,6,7	1,3,5,6,7	2,3,4,6,7	6,7,8			1,3,5,6,7	1,3,5,6,7	2,3,4,6,7	6,7,8						2,3,4,6,7	6,7,8
Evacuation		2						2	2	1 or 2	3	2			2	1 or 2	3	2						3	2
Management & Design		1,4,5						1,4,5	1	1,2,3,5	1,2,3,5	1,2,3,5			1	1,2,3,5	1,2,3,5	1,2,3,5						1,2,3,5	1,2,3,5

General Notes:



No Controls



Unsuitable Development Type (refer to General Note b)

- a Freeboard equals an additional height of 500mm.
- b The relevant environmental planning instruments (generally the Local Environmental Plan) identify development permissible with consent in various zones in the LGA. Notwithstanding, constraints specific to individual sites may preclude Council granting consent for certain forms of development on all or part of a site.
- c Filling of the site, where acceptable to Council, may change the FRP considered to determine the controls applied in the circumstances of individual applications.
- d Refer to Section 4.3.6 of the DCP for planning considerations for proposals involving only the erection of a fence. Any fencing that forms part of a proposed development is subject to the relevant flood effects and Structural Soundness planning considerations of the applicable development category.
- e Refer to Sections 4.3.5.2 and 4.3.5.3 of the DCP for special considerations such as for house raising proposals and development of properties identified for voluntary acquisition.
- f Terms in italics are defined in the glossary of this plan and Schedule 2 specifies development categories. These development types are generally as defined within Environmental Planning Instruments applying to the LGA.

Controls applicable to the reference numbers in the table follow on the next two pages.



Floor Level

- 1 All floor levels to be no lower than the 5 year flood level plus *freeboard* unless justified by site specific assessment.
- 2 *Habitable floor* levels to be no lower than the 100 year flood level plus *freeboard*.
- 3 *Habitable floor* levels to be no lower than the *PMF* level. *Non-habitable floor* levels to be no lower than the *PMF* level unless justified by a site specific assessment.
- 4 Floor levels to be no lower than the *design floor level*. Where this is not *practical* due to compatibility with the height of adjacent buildings, or compatibility with the floor level of existing buildings, or the need for access for persons with disabilities, a lower floor level may be considered. In these circumstances, the floor level is to be as high as *practical*, and, when undertaking alterations or additions, no lower than the existing floor level.
- 5 The level of *habitable floor areas* to be equal to or greater than the 100 year *flood* level plus *freeboard*. If this level is not *practical* for a development in a Business zone, the floor level should be as high as possible.
- 6 *Non-habitable floor* levels to be equal to or greater than the 100 year flood level plus freeboard where possible, or otherwise no lower than the 5 year flood level plus *freeboard* unless justified by site specific assessment.
- 7 A restriction is to be placed on the title of the land, pursuant to S.88B of the Conveyancing Act, where the lowest *habitable floor area* is elevated above finished ground level, confirming that the undercroft area is not to be enclosed, where Council considers this may potentially occur.

Building Components & Method

- 1 All structures to have *flood compatible building components* below the 100 year flood level plus *freeboard*.
- 2 All structures to have *flood compatible building components* below the *PMF* level.

Structural Soundness

- 1 Engineer's report to certify that the structure can withstand the forces of floodwater, debris and buoyancy up to and including a 100 year flood plus *freeboard*, or a *PMF* if required to satisfy evacuation criteria (see below). In the case of alterations or additions to an existing development, the structure to be certified is that which is proposed to be newly constructed or otherwise required to be of a specified standard to satisfy other controls.
- 2 Applicant to demonstrate that the structure can withstand the forces of floodwater, debris and buoyancy up to and including a 100 year flood plus *freeboard*, or a *PMF* if required to satisfy evacuation criteria (see below). An engineer's report may be required.
- 3 Applicant to demonstrate that any structure can withstand the forces of floodwater, debris and buoyancy up to and including a *PMF*. An engineers report may be required.

Flood Effects

- 1 Engineer's report required to certify that the development will not increase flood effects elsewhere, having regard to: (i) loss of flood storage; (ii) changes in flood levels and velocities caused by alterations to the flood *conveyance*; and (iii) the cumulative impact of multiple potential developments in the floodplain.
- 2 The flood impact of the development to be considered to ensure that the development will not increase flood effects elsewhere, having regard to: (i) loss of flood storage; (ii) changes in flood levels and velocities caused by alterations to the flood *conveyance*; and (iii) the cumulative impact of multiple potential developments in the floodplain. An engineer's report may be required.



Car Parking and Driveway Access

- 1 The minimum surface level of open car parking spaces or carports shall be as high as *practical* , and not below: (i) the 5 year flood level plus freeboard; or (ii) the level of the crest of the road at the location where the site has access; (which ever is the lower). In the case of garages, the minimum surface level shall be as high as *practical* , but no lower than the 5 year flood level plus freeboard.
- 2 The minimum surface level of open car parking spaces, carports or garages, shall be as high as *practical* .
- 3 Garages capable of accommodating more than 3 motor vehicles on land zoned for urban purposes, or *enclosed car parking* , must be protected from inundation by floods equal to or greater than the 100 year
- 4 The driveway providing access between the road and parking space shall be as high as *practical* and generally rising in the egress direction.
- 5 Where the level of the driveway providing access between the road and parking space is lower than 0.3m below the 100 year flood, the following condition must be satisfied - the depth of inundation on the driveway during a 100 year flood shall not exceed: (i) the depth at the road; or (ii) the depth at the car parking space. (Refer to Schedule 3). A lesser standard may be accepted for single detached dwelling houses where it can be demonstrated that risk to human life would not be compromised.
- 6 *Enclosed car parking* and car parking areas accommodating more than 3 vehicles (other than on Rural zoned land) with a floor level below the 5 year flood level plus *freeboard* or more than 0.8m below the 100 year flood level, shall have *adequate warning systems, signage and exits* .
- 7 Restraints or vehicle barriers to be provided to prevent floating vehicles leaving a site during a 100 year flood.
- 8 Driveway and parking space levels to be no lower than the *design ground/floor levels* . Where this is not *practical* , a lower level may be considered. In these circumstances, the level is to be as high as *practical* , and, when undertaking alterations or additions, no lower than the existing level.

- Note:**
- a. A flood depth of 0.3m is sufficient to cause a small vehicle to float.
 - b. Enclosed car parking is defined in the glossary and typically refers to carparks in basements.

Evacuation

- 1 Reliable access for pedestrians or vehicles required during a 100 year flood.
- 2 Reliable access for pedestrians or vehicles is required from the building, commencing at a minimum level equal to the lowest *habitable floor* level to an area of refuge above the *PMF level* , or a minimum of 20% of the gross floor area of the dwelling to be above the *PMF* level. In the case of alterations or additions to an existing development, this may require retro-fitting the existing structure if required to support a refuge above the *PMF* .
- 3 The evacuation requirements of the development are to be considered. An engineers report will be required if circumstances are possible where the evacuation of persons might not be achieved within the *effective warning time* .

Management and Design

- 1 If this application involves subdivision, Applicant to demonstrate that potential development as a consequence of the subdivision, can be undertaken in accordance with this DCP.
- 2 *Site Emergency Response Flood Plan* required where floor levels are below the *design floor level* , (except for single dwelling-houses).
- 3 Applicant to demonstrate that area is available to store goods above the 100 year flood level plus *freeboard* .
- 4 Applicant to demonstrate that area is available to store goods above the *PMF* level.
- 5 No storage of materials below the *design floor level* which may cause pollution or be potentially hazardous during any flood.



A5.9.6 Controls for General Development

This sub-section details the controls that apply to general development (excluding fencing) on flood liable land other than land affected only by local overland flooding. The development controls are graded relative to the severity and frequency of the potential floods.

The objectives of the controls for general development are:

- (a) To ensure the proponents of the development and the community in general are fully aware of the potential flood hazard and consequent risk associated with the use and development of land within the floodplain.
- (b) To require development with high sensitivity to flood damages or danger to life to be sited and designed so that it is subject to minimal flood hazard.
- (c) To allow development with low sensitivity to flood damages or danger to life to be located within a floodplain subject to design and siting controls and provided the chance of personal harm and damage to property is minimised.
- (d) To ensure that the design and siting controls and built form outcomes required to address the flood hazard do not result in unreasonable impacts on the:
 - › amenity and character of an area;
 - › streetscape and the relationship of the building to the street;
 - › social and economic outcomes; and the
 - › environment and ecology.
- (e) To ensure the flood risk within the development, comprising danger to life and damage to property, is minimised and not increased beyond the level acceptable to the community.
- (f) To ensure that the proposed development does not exacerbate flooding on other properties.

Performance Criteria

The performance criteria for general development are:

- (a) The flood risk associated with the development comprising danger to life and damage to property is minimised and not increased beyond the level acceptable to the community.
- (b) The additional economic and social cost which may arise from damage to property from flooding is not greater than that which can reasonably be managed by the property owner and general community. The cost of damages that may be incurred over the expected life of a development



- should be no greater than that which could be reasonably expected to be met by the occupants and/or the developer without Government assistance.
- (c) Effective warning time and reliable access is available for evacuation from an area potentially affected by all floods to an area free of risk from flooding.
 - (d) Motor vehicles associated with the development are able to be relocated, undamaged, to an area with substantially less likelihood from flooding, within the effective warning time.
 - (e) Appropriate procedures (such as warning systems, signage or evacuation drills) for land use categories of “critical uses and facilities” and “sensitive uses and facilities” be in place, if necessary, so that people are aware of the need to evacuate personnel and relocate goods and motor vehicles during a flood, and are capable of identifying an appropriate evacuation route.
 - (f) Development does not detrimentally increase the potential flood effects on other development or properties either individually or in combination with the cumulative impact of development that is likely to occur in the same floodplain. Development should not change the height or behaviour of floodwaters elsewhere in the floodplain in a manner which is likely to affect other property. The assessment of these effects must include the potential for similar impacts that would arise as a consequence of other development in the floodplain that has the potential to occur in the future under current zoning and planning controls.
 - (g) Development does not result in significant impacts upon the amenity of an area (e.g. by way of unacceptable overshadowing of adjoining properties) or privacy impacts (e.g. by unsympathetic house-raising).
 - (h) Development must be compatible with the existing and planned streetscape and character of the locality.
 - (i) The design of car parking (enclosed or uncovered) and associated driveways should not result in unacceptable environmental or amenity impacts such as visual intrusion from elevated driveways and parking structures and overshadowing of adjoining residential properties.
 - (j) The proposal must not have an unacceptable adverse impact upon the ecological value of the waterway corridors, and where possible, should provide for their enhancement.

Prescriptive Controls

The prescriptive controls for general development are:

- (a) Compliance with the requirements of the floodplain matrix as shown above.



(b) Development within the commercial centres must ensure that design solutions address flood risk management objectives as well as providing appropriate urban design outcomes, particularly in regard to:

- (i) Ground floor levels that are consistent with existing adjoining commercial development or form part of an integrated design which incorporate the frontage of a whole street block. Note: design solutions could include, flood proofed shop front windows at street level and confined active spaces (such as eating areas) at the street level which are substantially constructed of flood compatible materials and building components or able to be closed off with flood proof doors. Ground floor areas away from the street interface may vary subject to being adequately integrated.
- (ii) Acceptable access for persons with disabilities; and
- (iii) An overall building height that is compatible with the existing and planned streetscape.

(c) Proposals for house raising must provide appropriate documentation including:

- (i) a report from a suitably qualified engineer to demonstrate that the raised structure will not fail from the forces of floodwaters in a 100 year ARI flood; and
- (ii) the provision of details such as landscaping and architectural enhancements which ensure that the resultant structure will not result in significant adverse impacts upon the amenity and character of an area.

A5.9.7 Controls for Fencing (on flood liable land)

Fencing can have a significant influence on the distribution of flood waters. The implications of fencing are greater where flood waters are deeper and faster moving such as is expected in a high flood risk precinct.

The objectives of the controls for fencing are to ensure that development involving fencing has fencing constructed:

- (a) in a manner that does not affect the flow of flood waters so as to result in additional flood impacts on surrounding land; and
- (b) so as to withstand the forces of floodwaters, or collapse in a controlled manner to prevent the undesirable impediment of flood waters.



The performance criteria for fencing are:

- (a) Fencing is to be constructed in a manner that does not affect the flow of flood waters so as to detrimentally change flood behaviour or increase flood levels on surrounding land.
- (b) Ability to be certified by a suitably qualified engineer, that the proposed fencing is adequately constructed so as to withstand the forces of floodwaters, or collapse in a controlled manner to prevent the undesirable impediment of flood waters.

The prescriptive controls for fencing are:

- (a) Fencing within a High Flood Risk Precinct must be security/ permeable/ open type/safety fences. Council may require such fencing to be able to be opened at the bottom with the force of floodwaters. (This requirement may be secured by a Section 88B instrument burdening the title of the land).
- (b) An applicant will need to demonstrate that any fence would create no impediment to the flow of floodwaters. Appropriate fences must satisfy the following:-
 - An open collapsible hinged fence structure or pool type fence;
 - Other than a brick or other masonry type fence (which will generally not be permitted); or
 - A fence type and siting criteria as prescribed by Council.

A5.9.8 Controls for Overland Flow

The effects of overland flow, also defined as local overland flooding, are to be assessed in the same manner as mainstream flooding. In addition there are other specific considerations as outlined below.

- (a) The objective of the control for overland flow is to ensure that the impacts and flood risks associated with overland flow are addressed when assessing a development proposal.
- (b) The performance criteria for general flood prone land apply.
- (c) The prescriptive controls for overland flow are:



- (i) Proposals involving collecting and piping overland flow through the subject property or upgrading a section of Council's existing pipe infrastructure, will generally not be acceptable for the following reasons:
 - › there is a substantial potential for system blockage due to the limited number of inlets available;
 - › the natural detention storage available within the catchment is reduced and flow velocities are increased; and
 - › due to greater rates of flow, it may cause localised increases in hazard at the system outlet and greater scour of natural creeks and/or disturbance of the downstream river bed.
- (ii) Proposed land subdivisions of lots affected by overland flow will not be approved unless the applicant can demonstrate to Council that it is possible to provide a development on the newly created lot that realises the full floor space ratio (FSR) potential of the lot and provides suitable private open space while meeting the overland flow management criteria outlined in this document.
- (iii) Applicants are reminded that Council has the authority under section 124 of the Local Government Act to require the removal of fencing which contravenes these objectives and controls.

A5.9.9 Information Requirements

This section outlines the information that is likely to be required in the formulation of a competent development proposal on flood liable land and to assess the acceptability of the proposal.

To ensure that adequate information is available in the formulation and assessment of a development proposal on flood liable land:

Applications must include information that addresses all relevant controls listed above, and the following matters as applicable.

- (a) Applications for Concessional Development to an existing dwelling on flood liable land shall be accompanied by documentation from a registered surveyor confirming existing floor levels.
- (b) A survey plan showing: -
 - › The position of the existing building/s or proposed building/s;



- The existing ground levels to Australian Height Datum (AHD) around the perimeter of the building and contours of the site; and
- The existing or proposed floor levels to AHD.

Applications for earthworks, filling of land and subdivision shall be accompanied by a survey plan (with a contour interval of 0.25m) showing relative levels to AHD.

For large scale developments, or developments in critical situations a flood study using a fully dynamic one or two dimensional computer model may be required. For smaller developments a suitable flood study may be required together with any relevant Council Drainage Design Code and the Floodplain Development Manual. From a flood study, the following information shall be submitted in plan form:

- water surface contours (including the 100 year flood and PMF extents);
- velocity vectors;
- velocity and depth product contours;
- delineation of Flood Risk Precincts relevant to individual floodplains; and
- both existing and proposed flood profiles for the full range of events for total development including all structures and works (such as revegetation/ enhancements).
- This information is required for the pre-developed and post-developed scenarios.
- Where the controls for a particular development proposal require an assessment of structural soundness during potential floods, the following impacts must be addressed:
 - hydrostatic pressure;
 - hydrodynamic pressure;
 - impact of debris; and
 - buoyancy forces.
- Foundations need to be included in the structural analysis.

A5.9.10 Terms Used in this Section of the Plan

Adequate Warning Systems, Signage and Exits is where the following is provided:



- (a) an audible and visual alarm system which alerts occupants to the need to evacuate, sufficiently prior to likely inundation to allow for the safe evacuation of pedestrians and vehicles;
- (b) signage to identify the appropriate procedure and route to evacuate; and
- (c) exits which are located such that pedestrians evacuating any location during any flood do not have to travel through deeper water to reach a place of refuge above the 100 year flood, away from the enclosed car parking.

Annual is a dwelling site in a caravan park used as a “holiday van” site. “Holiday van” is defined in the Local Government (Manufactured Home Estates, Caravan Parks, Camping Grounds and Moveable Dwellings) Regulation 2005 as “a moveable dwelling (other than a tent) that is or usually is continuously located on a short-term site and used primarily by its owner for occasional occupancy for holiday purposes”.

Australian Height Datum (AHD) is a common national plane of level corresponding approximately to mean sea level.

Average Recurrence Interval (ARI) means the long-term average number of years between the occurrence of a flood as big as, or larger than, the selected event. For example, floods with a discharge as great as, or greater than, the 20 year ARI flood event will occur on average once every 20 years. ARI is another way of expressing the likelihood of occurrence of a flood event.

Compensatory Works refers to earthworks where material is excavated (or “cut”) from one location in the floodplain and placed (or “filled”) at another location in the floodplain, with no net importation of fill material, such that the volume available for storage of flood waters is not altered for all floods.

Conveyance is a direct measure of the flow carrying capacity of a particular cross-section of a stream or stormwater channel. (For example, if the conveyance of a channel cross-section is reduced by half, then the flow carrying capacity of that channel cross-section will also be halved).

Design floor level or **ground level** means the minimum floor level that applies to the development. If the development is concessional development, this level is determined based on what land use category would apply if it was not categorised as Concessional Development.

DISPLAN means a step by step sequence of previously agreed roles, responsibilities, functions, actions and management arrangements for the conduct of a single or series of



connected emergency operations, with the object of ensuring the coordinated response by all agencies having responsibilities and functions in emergencies.

Ecologically Sustainable Development (ESD) is using, conserving and enhancing natural resources so that ecological processes, on which life depends, are maintained, and the total quality of life, now and in the future, can be maintained or increased.

Effective warning time is the time available after receiving advice of an impending flood and before the floodwaters prevent appropriate flood response actions being undertaken. The effective warning time is typically used to move farm equipment, move stock, raise furniture, evacuate people and transport their possessions.

Enclosed car parking means car parking which is potentially subject to rapid inundation, which consequently increases danger to human life and property damage (such as basement of bunded car parking areas). The following criteria apply for the purposes of determining what is enclosed car parking:

- (a) Flooding of surrounding areas may raise water levels above the perimeter which encloses the car park (normally the entrance), resulting in rapid inundation of the car park to depths greater than 0.8m, and
- (b) Drainage of accumulated water in the car park has an outflow discharge capacity significantly less than the potential inflow capacity.

Flood is a relatively high stream flow which overtops the natural or artificial banks in any part of a stream, river, estuary, lake or dam, and/or local overland flooding associated with major drainage as defined by the FDM before entering a watercourse.

Note: Consistent with the Floodplain Development Manual, this section of the DCP does not apply in the circumstances of local drainage inundation as defined in the Floodplain Development Manual and determined by Council. Local drainage problems can generally be minimised by the adoption of urban building controls requiring a minimum difference between finished floor and ground levels.

Flood awareness is an appreciation of the likely effects of flooding and knowledge of the relevant flood warning and evacuation procedures.

Flood compatible building components means a combination of measures incorporated in the design and/or construction and alteration of individual buildings or structures subject to flooding, and the use of flood compatible materials for the reduction or elimination of flood damage.

Note: A list of typical flood compatible building components is provided in [Schedule 1](#).



Flood compatible materials include those materials used in building which are resistant to damage when inundated.

Note: A list of typical flood compatible building components is provided in [Schedule 1](#).

Flood evacuation strategy means the proposed strategy for the evacuation of areas within effective warning time during periods of flood as specified within any policy of Council, the FRMP, the relevant SES Flood Plan, by advices received from the State Emergency Services (SES) or as determined in the assessment of individual proposals.

Flood prone land (being synonymous with flood liable and floodplain) is the area of land which is subject to inundation by the probable maximum flood (PMF).

Floodplain Development Manual (FDM) refers to the document dated April 2005, published by the New South Wales Government and entitled "Floodplain Development Manual: the management of flood liable land".

Floodplain Risk Management Plan (FRMP) means a plan prepared for one or more floodplains in accordance with the requirements of the Floodplain Development Manual or its predecessors.

Floodplain Risk Management Study (FRMS) means a study prepared for one or more floodplains in accordance with the requirements of the Floodplain Development Manual or its predecessors.

Freeboard provides reasonable certainty that the risk exposure selected in deciding on a particular flood chosen as the basis for a FPL is actually provided. It is a factor of safety typically used in relation to the setting of flood levels, levee crest levels, etc. (as specified at Section K5 of the FDM). Freeboard is included in the flood planning level.

Habitable floor area means:

in a residential situation: a living or working area, such as a lounge room, dining room, rumpus room, kitchen, bedroom or workroom;

- (iv) in an industrial or commercial situation: an area used for offices or to store valuable possessions susceptible to flood damage in the event of a flood.

Note: Separate considerations are specified for the car parking area of a development irrespective of the land use with which it is associated.



Hazard is a source of potential harm or a situation with a potential to cause loss. In relation to this plan, the hazard is flooding which has the potential to cause harm or loss to the community.

Infill development is development which is proposed within established existing urban area and usually involves the development of a vacant residential site, or the removal of an existing residential or retail/commercial building to provide a replacement building for a similar use.

Local drainage means small scale inundation in urban areas outside the definition of major drainage as defined in the Floodplain Development Manual. Local drainage problems invariably involve shallow depths (less than 0.3m) with generally little danger to personal safety.

Local overland flooding (being synonymous with overland flow) means inundation by local runoff rather than overbank discharge from a stream, river, estuary, lake or dam.

Outbuilding means a building that is ancillary to a principal residential building and includes sheds, garages, carports and similar buildings but does not include granny flats.

Practical means that which in the opinion of Council can be achieved within the design of the development, while not necessitating:

- (a) floor levels to be raised in a way that would unreasonably hinder access to and from existing floor levels or ground levels on the same site or adjacent public areas; and
- (b) the raising of a structure to a height that would result in unacceptable impacts on the amenity of adjacent residential properties; and
- (c) the height or presentation of a building that would be inconsistent with the existing or planned streetscape.

Note: Examples of where the preferred design may not be practical include:

Example 1: A minor extension to an existing dwelling (falling within the “Concessional Development” land use category) where an additional room would require a floor level higher than what otherwise exists within the dwelling constraining internal movements or resulting in an unusual external appearance to the building.

Example 2: The rebuilding or refitting of a singular shop in a traditional street shopping centre where existing ground floor levels of the site and adjoining sites relate closely to the footpath level. In this case the width of the site would not be sufficient to allow for a



redevelopment that could incorporate a podium level or colonnade along the street frontage at the preferred design floor flood level while remaining compatible with the existing or planned streetscape. The site would have insufficient frontage to the road to enable the creation of a site specific streetscape presentation that was compatible with, but not consistent with that otherwise prevailing in the shopping centre (eg. the site does not occupy a whole street block).

Example 3: The topographical site constraints of a site would require a driveway to be elevated more than 1 metre above natural ground in a location that would not allow the driveway to be incorporated in the final landscape or visually and acoustically screened from habitable rooms associated with dwellings on the site or adjacent properties. The resultant garage design and driveway levels may also be unable to meet Australian Standards. In this case the development of the site for the proposed residential purposes would otherwise be a reasonable expectation having regard to the planning controls and existing development in the locality.

Primary habitable floor area means the majority of habitable floor area and in a residential situation includes the majority of bedrooms, main living area, kitchen and first bathroom.

Probability is a statistical measure of the expected chance of flooding (see ARI).

Probable maximum flood (PMF) is the largest flood that could conceivably occur at a particular location, usually estimated from probable maximum precipitation. In the case of the Berrima Floodplain, the PMF is identical to the “extreme flood” referred to in the Berrima Flood Study (Revised) (2000) and the Berrima Floodplain Risk Management Study (2002), or later updates to these studies.

Probable maximum precipitation (PMP) is the greatest depth of precipitation for a given duration meteorologically possible over a given size storm area at a particular location at a particular time of the year, with no allowance made for long-term climatic trends (World Meteorological Organisation, 1986). It is often the primary input to the estimation of the probable maximum flood.

Raised fill pad level is a raised area of ground upon which a dwelling or ancillary buildings must be constructed on rural or other non-urban zoned lands.

Rebuilt dwelling refers to the construction of a new dwelling on an allotment where an existing dwelling is demolished.

Reliable access during a flood means the ability for people to safely evacuate an area subject to flooding, having regard to the depth and velocity of flood waters and the



suitability of the evacuation route, without a need to travel through areas where water depths increase.

Risk means the chance of something happening that will have an impact. It is measured in terms of consequences and probability (likelihood). In the context of this plan, it is the likelihood of consequences arising from the interaction of floods, communities and the environment.

Site Emergency Response Flood Plan (not being an SES Flood Plan) is a management plan that demonstrates the ability to safely evacuate persons and include a strategy to move goods above the flood level within the available warning time. This Plan must be consistent with any relevant flood evacuation strategy, flood plan or similar plan.

Survey plan is a plan prepared by a registered surveyor which shows the information required for the assessment of an application in accordance with the provisions of this Plan.

Subdivision where referred to in the context of flood risk management controls means any subdivision of land which involves the creation of new allotments.

Tourist related development where referred to in the context of flood risk management controls means cabins, camping or caravan sites which do not provide for long term occupation or any tourist facility which does not include accommodation.

Schedule of Flood Compatible Materials & Building Components

Building Component	Flood compatible Material	Building Component	Flood Compatible Material
Flooring and Sub-floor Structure	<ul style="list-style-type: none"> concrete slab-on-ground monolith construction suspension reinforced concrete slab. 	Doors	<ul style="list-style-type: none"> solid panel with water proof adhesives flush door with marine ply filled with closed cell foam painted metal construction aluminium or galvanised steel frame



Building Component	Flood compatible Material	Building Component	Flood Compatible Material
Floor Covering	<ul style="list-style-type: none"> • clay tiles • concrete, precast or in situ • concrete tiles • epoxy, formed-in-place • mastic flooring, formed-in-place • rubber sheets or tiles with chemical-set adhesives • silicone floors formed-in-place • vinyl sheets or tiles with chemical-set adhesive • ceramic tiles, fixed with mortar or chemical-set adhesive • asphalt tiles, fixed with water resistant adhesive 	Wall and Ceiling Linings	<ul style="list-style-type: none"> • fibro-cement board • brick, face or glazed • clay tile glazed in waterproof mortar • concrete • concrete block • steel with waterproof applications • stone, natural solid or veneer, waterproof grout • glass blocks • glass • plastic sheeting or wall with waterproof adhesive
Wall Structure	<ul style="list-style-type: none"> • solid brickwork, blockwork, reinforced, concrete or mass concrete 	Insulation Windows	<ul style="list-style-type: none"> • foam (closed cell types) • aluminium frame with stainless steel rollers or similar corrosion and water resistant material.



Building Component	Flood compatible Material	Building Component	Flood Compatible Material
Roofing Structure (for Situations Where the Relevant Flood Level is Above the Ceiling)	<ul style="list-style-type: none"> • reinforced concrete construction • galvanised metal construction 	Nails, Bolts, Hinges and Fittings	<ul style="list-style-type: none"> • brass, nylon or stainless steel • removable pin hinges • hot dipped galvanised steel wire, nails or similar.
Electrical and Mechanical Equipment For dwellings constructed on land to which this Plan applies, the electrical and mechanical materials, equipment and installation should conform to the following requirements.		Heating and Air Conditioning Systems Heating and air conditioning systems should, to the maximum extent possible, be installed in areas and spaces of the house above the relevant flood level. When this is not feasible every precaution should be taken to minimise the damage caused by submersion according to the following guidelines.	
Main power supply Subject to the approval of the relevant authority the incoming main commercial power service equipment, including all metering equipment, shall be located above the relevant flood level. Means shall be available to easily disconnect the dwelling from the main power supply.		Fuel Heating systems using gas or oil as a fuel should have a manually operated valve located in the fuel supply line to enable fuel cut-off.	



Building Component	Flood compatible Material	Building Component	Flood Compatible Material
<p>Wiring</p> <p>All wiring, power outlets, switches, etc., should, to the maximum extent possible, be located above the relevant flood level. All electrical wiring installed below the relevant flood level should be suitable for continuous submergence in water and should contain no fibrous components. Earth core linkage systems (or safety switches) are to be installed. Only submersible-type splices should be used below the relevant flood level. All conduits located below the relevant designated flood level should be so installed that they will be self-draining if subjected to flooding.</p>	<p>Installation</p> <p>The heating equipment and fuel storage tanks should be mounted on and securely anchored to a foundation pad of sufficient mass to overcome buoyancy and prevent movement that could damage the fuel supply line. All storage tanks should be vented to an elevation of 600 millimetres above the relevant flood level.</p>		
<p>Equipment</p> <p>All equipment installed below or partially below the relevant flood level should be capable of disconnection by a single plug and socket assembly.</p>	<p>Ducting</p> <p>All ductwork located below the relevant flood level should be provided with openings for drainage and cleaning. Self draining may be achieved by constructing the ductwork on a suitable grade. Where ductwork must pass through a water-tight wall or floor below the relevant flood level, the ductwork should be protected by a closure assembly operated from above relevant flood level.</p>		
<p>Reconnection</p> <p>Should any electrical device and/or part of the wiring be flooded it should be thoroughly cleaned or replaced and checked by an approved electrical contractor before reconnection.</p>	<p>Ancillary Structures (steps, pergolas, etc)</p> <p>Suitable water tolerant materials should be used such as masonry sealed hardwood and corrosive resistant metals. Copper Chrome Arsenate (CCA) treated timber is not a suitable material.</p>		

Section 6 Additional Controls

A6.1 Introduction

Some sites, by the nature of their location or particular characteristics, or the environmental implications of their use, may require further controls. In some cases applicants may need to obtain additional technical reports to support the Development Application.

Objectives and controls for the location and design of farm buildings are also contained in this section to avoid repetition as such development may occur with a range of specific rural land uses.

A6.2 Bushfire Prone Land

A report may be required if the subject property is subject to Bush Fire Risk under the Rural Fire Service's document "*Planning for Bushfire Protection*". A copy of this and other useful documents may be obtained from the Rural Fire Service website.

An assessment under this document is required to determine appropriate standards for distances from vegetation and standard of construction for the building along with a variety of other matters.

All applicants seeking to develop rural land should obtain specialised advice on this matter. Specified types of development may be 'Integrated' development and require referral to the NSW Rural Fire Service.

Note: The Rural Fire Service recommends referring to the following documents for further advice:

- Planning for Bushfire Protection guidelines, 2006
- Section 100B of the Rural Fires Act 1997
- Section 79BA of the Environmental Planning & Assessment Act 1979

A6.2.1 Bushfire Assessment Report

The purpose of a Bushfire Assessment Report is to identify the level of bushfire threat so as to prevent the loss of life and property due to bushfires by discouraging the establishment of incompatible land uses in bushfire-prone areas.

SECTION 6 ADDITIONAL CONTROLS

Depending upon the size and likely usage of the proposed development, the Building Code of Australia (BCA) may require the provision of building designs and fire fighting equipment that allow people to escape from the building in an emergency and to fight a fire outbreak. An assessment of your proposal against the BCA will be required to determine what, if any, BCA requirements are applicable.

If the development will be located in a bushfire-prone area, additional bushfire protection requirements may apply, particularly when visitors (who may not be familiar with the area or with bushfires) and staff may be exposed to bushfire attacks.

A6.2.2 Development Controls for Bushfire Prone Land

If the proposed development is within a designated bushfire prone area, the following controls shall apply:

- (a) All rural development (including the upgrade of existing buildings/structures, dwellings, industry) must comply with the requirements of the Building Code of Australia and associated Australian Standards.
- (b) Council may consult with the NSW Rural Fire Service to determine bushfire safety requirements. In some instances a bush fire safety analysis may be required to be prepared by a suitable qualified person (for more information in this regard please contact Council), and submitted with the land use application.
- (c) Compliance is required with the most recent version of the document Planning for Bushfire Protection produced by the NSW Rural Fire Service. (Further information is available from Council).

A6.3 Contaminated or Potentially Contaminated Land

A6.3.1 Introduction

Contaminated land can have major economic, legal and planning implications for the community. Contamination can limit land use potential or increase costs for developers and councils. Their investigation and clean-up is important to protect human health and the environment.

Land contamination is most often the result of past uses. It can arise from activities that took place on or adjacent to a site and be the result of improper chemical handling or disposal practices, or accidental spillages or leakages of chemicals during manufacturing or storage. Activities not directly related to the site may also cause contamination; for example, from diffuse sources such as polluted groundwater migrating under a site or dust settling out from industrial emissions.

SECTION 6 ADDITIONAL CONTROLS

Council will require a Contamination / Remediation report to be prepared for all land that is known to be, or reasonably suspected of being contaminated. This report needs to be prepared by a suitably qualified professional and must address the provisions of Council's Contaminated Land Procedures Policy and State Environmental Planning Policy No 55 – Remediation of Land. Council can provide some information on potential contaminated sites.

A6.3.2 Council Requirements

- (a) Where there are indications that contamination is, or may be present, Council may require the applicant to undertake a site-specific Contamination Study.
- (b) In determining whether a site-specific Contamination Study is required, Council will consider the following questions:
 - (i) Is there any record of previous investigations of contamination on the land? If so, what were the results, including any previous initial evaluations?
 - (ii) Do existing records held by Council show that an activity identified as causing potential land contamination (refer to subclause (c) below) has ever been approved on the subject land?
 - (iii) Was the subject land at any time zoned for industrial, agricultural or defence purposes?
 - (iv) Is the subject land currently used for an activity listed in subclause (c) below?
 - (v) Is, or has the subject land ever been regulated through licensing or other mechanisms in relation to any activity listed in subclause (c) below?
 - (vi) Are there any land use restrictions on the subject land relating to possible contamination, such as notices issued by the EPA or other regulatory authority?
 - (vii) Does a site inspection conducted Council suggest that the site may have been associated with any activities listed in subclause (c) below?
 - (viii) Is Council aware of information concerning contamination impacts on land immediately adjacent to the subject land which could affect the subject land?
- (c) The potential contamination activities referred to in subclause (b) above are: acid/alkali plant and formulation, agricultural/horticultural activities,

SECTION 6 ADDITIONAL CONTROLS

airports, asbestos production and disposal , chemicals manufacture and formulation, defence works, drum re-conditioning works, dry cleaning establishments, electrical manufacturing (transformers), electroplating and heat treatment premises, engine works, explosives industry, gas works , iron and steel works, landfill sites, metal treatment, mining and extractive industries, oil production and storage, paint formulation and manufacture, pesticide manufacture and formulation, power stations, railway yards, scrap yards, service stations, sheep and cattle dips, smelting and refining, tanning and associated trades, waste storage and treatment, and wood preservation.

- (d) Where Council determines that further study is required, applicants will need to comply with the following requirements (overleaf):

Stage	Requirements
Stage 1— Preliminary Investigation	<p>The main objectives of a preliminary investigation are to:</p> <ul style="list-style-type: none"> ‣ identify any past or present potentially contaminating activities, ‣ provide a preliminary assessment of any site contamination and, if required, provide a basis for a more detailed investigation. A preliminary investigation is not necessary where contamination is not an issue.
Stage 2— Detailed Investigation.	<p>A detailed investigation is only necessary when a preliminary investigation indicates that the land is contaminated or that it is, or was, formally used for an activity identified by Council as possibly causing contamination and a land use change is proposed that has the potential to increase the risk of exposure to contamination.</p> <p>A detailed investigation will also need to be conducted as part of a remediation proposal.</p> <p>The objectives of a detailed investigation are:</p> <ul style="list-style-type: none"> ‣ to define the nature, extent and degree of contamination; to assess potential risk posed by contaminants to health and the environment; and ‣ to obtain sufficient information to develop a remedial action plan (RAP), if required.
Stage 3— Remedial Action Plan	<p>The objective of an RAP, or plan of remediation, is to set objectives and document the process to remediate the site.</p>

SECTION 6 ADDITIONAL CONTROLS

<p>Stage 4— Validation and Monitoring</p>	<p>The objective of validation and monitoring is to demonstrate whether the objectives stated in the RAP and any conditions of development consent have been achieved. SEPP 55 requires a notice of completion for all remediation work. Validation is an important prerequisite of this notice.</p> <p>It should be emphasised that not every site will require all four stages of investigation. An investigation may proceed directly to Stage 2 for example, if it is clear early on that the land has been used for an activity identified by Council as possibly causing contamination and the proposed change of use would increase the risk from contamination.</p> <p>Proponents may also choose not to proceed with the proposal and terminate the site investigation process at any stage. If a proponent decides to proceed with the proposal and provide the necessary information for consideration by the planning authority, they should engage suitably qualified contaminated land professionals who are experienced in contaminated site assessment and management.</p>
--	--

- (e) For further details on how Council will assess the information provided to it, applicants are directed to *State Environmental Planning Policy (SEPP) 55 – Remediation of Land*, key points from which are summarised below.

A6.4 Demolition of Existing Structures

Any development application that seeks approval for the demolition of an existing structure (including partial demolition of an existing structure) must prepare and submit a Demolition Work Plan. The only exception to this clause is work defined as Exempt Development under WLEP 2010.

All demolition work must comply with relevant guidelines including NSW Department of Environment and Conservation guidelines and Workcover Standards Australian Standard AS2601- 1991- Demolition of Structures.

In preparing a Demolition Plan, applicants must ensure that they address the following issues:

- (a) All Demolition must comply with all relevant Workcover standards, and any relevant guidelines /best practice notes by State Government Agencies.
- (b) All contaminated/hazardous materials must be removed, handled, transported and disposed of in accordance with the NSW Department of Environment and Conservation guidelines. Asbestos must be removed, transported and disposed of in accordance with Workcover requirements.

SECTION 6 ADDITIONAL CONTROLS

- (c) Prior to work commencing, security fencing and/or hoardings must be provided around the perimeter of the demolition site in order to prevent access by unauthorized persons. Dust controls must be implemented on site prior to and during demolition.
- (d) The Demolition Work Plan and associated application forms must contain the following information:
 - (i) A full description of any structures to be demolished,
 - (ii) Photographs of structures to be demolished
 - (iii) Identification of structures to be demolished shown on a site plan;
 - (iv) The amount and type of waste to be generated;
 - (v) Details of waste management, (including disposal and intended recycling. Note there are standards that apply to the type of building material that can be recycled. These should be consulted.)
 - (vi) Details of the intended waste contractor;
 - (vii) Details of any hazardous material to be removed including the method of removal, storage and disposal.

A6.5 Regional Wildlife Corridors

Regional Wildlife Corridors are nominated and mapped within the Illawarra Regional Environmental Plan No 1 and also included on the Natural Resources Sensitivity maps which form part of the WLEP 2010. Development proposed within these corridors may be subject to additional consultation to ensure the ongoing viability of the wildlife corridor.

Applications for development of land within or within close proximity of an identified Regional Wildlife Corridor may be required to restrict the range and nature of their development. Each case will be assessed on its merits.

A6.6 Development in the vicinity of a National Park or Nature Reserve

The Council shall not grant consent to an application for development on land that is located immediately adjacent to or within 500 metres of land that is a National Park or Nature Reserve, unless the Council has considered any comments from the Department of Environment and Conservation in relation to the likely effect of the proposed development, if any, on the National Park or Nature Reserve.

SECTION 6 ADDITIONAL CONTROLS

A6.7 Sites Requiring Geotechnical Reports

A Geotechnical Report, prepared and certified by a Council-accepted Geotechnical Engineer will need to be provided with all applications for development located within an area identified or potentially subject to geotechnical constraints, including land subject to instability, filling, or with a slope greater than 18 degrees.

Geotechnical reports may also be required in other instances depending on the nature of the proposed development and the particular circumstances and conditions of the site.

A6.8 Minimisation of External Impacts - Noise

There are two types of noise associated with rural activity that have the potential to lead to land use conflicts – ‘constant’ and ‘intermittent’.

Constant noise generally derives from plant and equipment such as compressors, pumps and generators. Such noise need not be occurring all the time for it to be considered ‘constant’. Pumps and generators which only operate for certain times of the day or certain days of the week may still be classified as ‘constant’ by the nature of the noise they emit.

Any increase above the general background noise level, particularly ‘constant’ noise, may be offensive to neighbours. Such noise will be particularly apparent at night when background noise is less and when sleep patterns can be disrupted.

Constant noise sources must not exceed 5dB(A) above background noise levels at any time when measured at the boundary with any adjoining property or public road.

Intermittent noise generally derives from moving machinery such as tractors and other farm management vehicles, traffic to and from the property due to the nature of the rural activity, or from seasonal activities such as bird scaring devices, or animal weaning.

Neighbours need to appreciate that such intermittent noise is part of the fabric of rural life. However, that said, a tractor which operates from early in the morning until late at night most days would be considered to be more ‘constant’ than ‘intermittent’ and noise abatement measures may be required.

In the case of animal noise from weaning and other stock or plant management practices, or occasional additional noise, such as a truck spreading fertiliser, Council encourages ‘good neighbour’ practices, both on the part of the source property and the adjoining property. Neighbours who are advised when particular farm activities which may impact on them are to occur are generally more tolerant than those who are caught by surprise.

A6.8.1 Objectives

The controls in the following sub-clause seek to achieve the following objectives:

SECTION 6 ADDITIONAL CONTROLS

- (a) To reduce the potential for noise-generated land use conflict by appropriately locating and designing rural development in relation to neighbouring developments.
- (b) To require the provision of noise attenuation measures in the design, construction and operation phase of any rural development or practice.
- (c) To ensure that best practice guidelines are met in the implementation of noise-generating activity.

A6.8.2 Controls

- (a) All applications for rural development shall indicate what machinery is required and clearly identify where such machinery will be located and what measures will be undertaken to ensure that constant noise does not exceed 5dB(A) above background noise levels when measured at the boundary with any adjoining property or public road.
- (b) All potential noise sources are to be sited as far away as possible from common property boundaries and sensitive areas such as neighbouring dwellings.
- (c) In the event that Council considers it likely that the proposed development could result in a noise nuisance being caused to neighbouring properties, an acoustic report, prepared by a qualified acoustic consultant, must be lodged with the application.
- (d) The acoustic report must include (but is not limited) to the following information:-
 - (i) Sample Methodology utilised including placement and location of sampling equipment, Details of Equipment used, times sampled
 - (ii) Conclusions from the study including a set of raw data obtained from sampling, details of any consultations / discussions with interested parties.
 - (iii) Full details of noise abatement measures recommended.

A6.9 Minimisation of External Impacts - Odour

As with noise, odour impacts can be generated from many rural activities. Odour may occur from the use of chemicals in rural industry, from waste products associated with farm management or with other farming practices such as the spreading of fertilisers.

A6.9.1 Objectives

The controls contained in the sub-clauses below are intended to achieve the following objectives.

SECTION 6 ADDITIONAL CONTROLS

- (a) o reduce the potential for land use conflict resulting from odours by appropriately locating rural developments in relation to neighbouring properties.
- (b) To ensure that odour producing activities such as composting and effluent collection, treatment, disposal or reuse, are managed in a way that does not cause odour nuisance to adjoining properties.
- (c) To ensure that best practice guidelines are applied in the management of farm activities which may result in odour problems.

A6.9.2 Controls

- (a) All applications for rural development shall indicate how odour-producing materials are to be managed to ensure that the impacts of such odours on neighbouring properties are minimised.
- (b) Storage facilities for materials which may generate odours are to be sited as far way as possible from common property boundaries and sensitive areas such as neighbouring dwellings.

A6.10 Minimisation of External Impacts - Outdoor Lighting

A6.10.1 Introduction

Council is concerned that poorly designed and improperly located external lighting can create significant light and glare pollution with adverse impacts on both the population and the environment.

External lighting is most usually installed to deter intruders, however, a number of studies indicate that there is no conclusive correlation between night lighting and a reduction in the crime rate. Most property crime is still committed during the day, or inside lit buildings. In fact, outside illumination can draw attention to the building and help criminals see what they are doing. Outdoor lighting should provide real security, not just a feeling of safety.

The external lighting of residential buildings or buildings frequently used at night is essential for the convenience and safety of residents and visitors, but again, suitable lighting fixtures and techniques are necessary to ensure there are no adverse impacts. Similarly, external lighting associated with outdoor activities such as tennis courts, outdoor recreation areas or pathways can impact on surrounding dwellings.

People are not the only ones affected. Researchers are only now beginning to understand the long term impacts of artificial night light on ecosystems. As development occurs in rural areas, light pollution can produce a state of continual 'twilight' in the bushland surrounding

SECTION 6 ADDITIONAL CONTROLS

such development which can affect wildlife breeding and feeding habits as well as the habits of the moths and other insects on which such wildlife depends. In some cases, certain trees may shed their leaves out of cycle, further disrupting the natural food chain.

The quality of the night sky is a highly valued asset of the Southern Highlands environment. Unlike city areas where ambient light significantly diminishes the ability to see the night sky, the Southern Highlands affords excellent night sky visibility, especially in our rural areas, and Council wants to protect this valuable asset.

Poorly directed external light is also a waste of the energy used to generate it and so contradicts Council's objectives for ecologically sustainable development.

These significant residential and environmental implications of light pollution can be easily avoided, without compromising the safety and convenience which external night lighting is intended to provide, through ensuring that new lighting fixtures are of a "full cutoff" type, that is, a type of fixture from which no light is emitted above the horizontal and no light dispersion or direct glare shines above a 90-degree, horizontal plane from the base of the fixture.

Using such fixtures is beneficial in three ways. First, glare is significantly decreased or even eliminated. Uncomfortable or temporary blinding from a glaring light can distract the eye and cast harsh shadows that create easy concealment opportunities for a trespasser. Second, shielded fixtures help control both the placement and the amount of light. Entrances, windows, and gates can be the focal points of a lighting scheme that does not over illuminate, but allows adequate and uniform visibility that dissipates shadows. Third, the downward concentration of light created by fully shielded fixtures typically requires a lesser wattage lamp than traditional lighting because every bit of illumination is directed where it can make a difference. A lesser wattage lamp can be used with associated cost benefits.

In addition to the "full cut-off" design, timers, dimmers, and motion sensors can all contribute to reducing the impact of night-time lighting with additional benefits. For example, lights triggered by motion sensors, are much more effective in indicating the presence of an intruder than lights which are on all night.

A6.10.2 Objectives

In assessing any land use application which includes the provision of external night lighting, Council will have due regard to the following objectives:

- (a) Lighting for security purposes shall be adequate for that purpose without drawing unnecessary attention to the development;
- (b) Lighting shall not adversely impact on surrounding development;
- (c) Lighting shall not create 'twilight' impacts on the surrounding environment;
and
- (d) Lighting shall not diminish the quality of the night sky.

SECTION 6 ADDITIONAL CONTROLS

A6.10.3 Controls

- (a) Outdoor lighting must be a “full cutoff light fixture”, i.e. a type of fixture with no light emitted above the horizontal and no light dispersion or direct glare to shine above a 90-degree, horizontal plane from the base of the fixture.
- (b) All outdoor lighting fixtures shall be designed, installed, located and maintained to avoid glare on to adjacent properties or streets
- (c) All direct illumination shall be kept within the boundaries of the subject property.
- (d) Accent lighting, when so approved, shall be directed downward on to the building or object and not toward the sky or on to adjacent properties. Direct light emissions shall not be visible above the roof line or beyond the building edge.
- (e) Spotighting on landscaping and foliage shall be limited to 150 watts incandescent. The lamp shall be shielded and not create disabling or nuisance glare.
- (f) Timers shall be accurately set to ensure that lighting is used only when natural light is insufficient.

A6.11 Construction of Private Roads

The construction of a private road needs to take into consideration a number of factors to ensure a practical and sustainable end result. Road construction can have a detrimental impact on the environment if inappropriately sited, and can have ongoing costs to the property owner if not constructed to a sufficiently high quality.

All road construction should aim to obtain the most environmentally sustainable option. Council and the State government have best practice methodologies for road construction and it strongly advised that these are consulted before planning and construction phases.

Materials used should blend in with the landscape with ‘soft’ edges to enhance rural character.

A6.12 Property Entrances and Front Fencing

Property entrances and front gates and fencing play an important role in adding character to the rural landscape. Applicants are required therefore to give careful consideration to the design of these aspects of their property.

SECTION 6 ADDITIONAL CONTROLS

It is acknowledged that gate and fence requirements will vary throughout the rural areas depending on the style of existing fencing, the style of development, the purpose of the fencing and the nature of the roadway. Regardless of purpose, however, fencing and gate materials need to reflect the existing rural character and not impede views or vistas from the public domain, including roads.

Front entrances need to provide safe access to and from the property for the full range of vehicles expected to access the site on a regular basis. Where Council can reasonably expect that a property will require access from large or long vehicles applicants will be required to design their affected property entrances to a higher standard than would be the case where no such large vehicle movements are anticipated. For example, Council may require a wider entrance opening, suitably splayed and surfaced to meet the requirements of such vehicles in all weather. The standard of design will also take into account the width and standard of the access road and the need to manage roadside water flows during heavy rain events.

Gates are to be set back a minimum of 20m from the road frontage. This allows for safe off-road stopping to open and close gates, as is often required on a rural property. A setback greater than 20 metres may be required when it is expected that over-long vehicles will need to access the property on a regular basis.

A6.12.1 Objectives

In assessing applications which include the construction of, or alterations to, property entrances, gates and front fencing, Council will be satisfied that the following objectives have been addressed:

- (a) That front fences are designed and constructed to ensure that any stock on the subject property are adequately contained on-site.
- (b) That front entrances are designed for the practical and safe ingress and egress of all vehicles that will regularly utilise the property.
- (c) That the standard and style of fencing is compatible with and enhances the existing rural landscape and other fencing within the vicinity.
- (d) That fencing does not impede view lines and view corridors from the public domain, including roads.
- (e) That fencing does not impede overland water flows including stormwater drainage.
- (f) That property gates are functional and appropriate to a rural locality.

A6.12.2 Development Controls

To meet these objectives, Council requires compliance with the following controls.

SECTION 6 ADDITIONAL CONTROLS

- (a) Front entrances shall be designed to the satisfaction of Council with regard to width, degree of splay and surface materials to ensure that vehicles may access the site in all weather without adversely impacting on the road surface or traffic flows.
- (b) Gates are to be setback a minimum of 20m from the road frontage. Where Council believes that over-long vehicles will access the site on a regular basis, a setback great than 20 metres may be required.
- (c) Gates are to be of a design appropriate to a rural landscape.
- (d) Fencing is to be constructed of traditional rural materials such as timber post and rail, or timber and wire, depending on whether the primary objective is visual, or to effectively contain stock.
- (e) Solid front fences are not permitted except for short distances as gate supports on either side of the front entrance.
- (f) Timber paling fencing is not permissible on any rural property.
- (g) Fencing must not impede view lines accessed from the public domain, including roads.
- (h) Fencing must not prevent the natural flow of overland water, such as stormwater and runoff.

A6.13 Roadside Stalls

Roadside stalls are permissible with consent in the RU2 Rural Landscape and E3 Environmental Management zones. Permission is not required in the RU1 Primary Production zone.

Under WLEP 2010 a roadside stall is defined as *“a place or temporary structure used for retail selling of agricultural produce or hand crafted goods (or both) produced from the property on which the stall is situated or from an adjacent property”* with the maximum permissible area being 20m².

Roadside stalls can add character to the rural landscape and offer tourists and locals a source of farm-fresh produce provided they are well located and managed. The following objectives and associated objectives reflect Council’s desire to achieve such an end.

A6.13.1 Objectives

In assessing an application for a roadside stall, Council shall consider the extent to which the application meets the following objectives:

- (a) Roadside stalls shall be appropriately located to ensure that patrons’ parking and movement around the stall does not present a danger to themselves or passing traffic.

SECTION 6 ADDITIONAL CONTROLS

- (b) Roadside stalls shall be designed of traditional materials to complement the rural landscape.
- (c) Roadside stalls shall be designed to be easily cleaned and maintained to remain an attractive feature of the rural landscape.

A6.13.2 Controls

To achieve the above objectives, roadside stalls shall be:

- (a) located within the property boundary
- (b) located at a point which does not impede the line of sight of passing traffic.
- (c) located where associated roadside parking poses no potential danger to passing traffic, parked cars or stall patrons.
- (d) constructed of materials which complement the surrounding environment.
- (e) constructed to ensure that produce is protected from weather extremes to ensure it remains safe for consumption.
- (f) properly maintained to ensure they remain clean and attractive.

A6.14 Truck Parking

Council appreciates that many rural activities require the use of a truck for the transfer of stock and produce, or other heavy vehicle equipment for adequate property maintenance. While Council has no objection to the parking of trucks and earth moving equipment for use primarily on the property where it is located, Council is not prepared to allow the use of rural properties as de-facto truck depots.

Under WLEP 2010 'truck depot' means 'a building or place used for the servicing and parking of trucks, earthmoving machinery and the like'. Truck depots are only permissible with consent in the IN1 General Industrial, IN2 Light Industrial and IN3 Heavy Industrial zones.

The following objectives and controls apply to truck parking which is ancillary to rural activity.

A6.14.1 Objectives

- (a) To allow for truck parking on rural properties where the truck is used in conjunction with a rural, agricultural, or rural industrial use carried out on the property.

SECTION 6 ADDITIONAL CONTROLS

- (b) To ensure that any trucks parked on the property pose no safety threat to residents or visitors to the site.
- (c) To ensure that trucks that are parked on rural properties are not utilised for any business not connected with the property.

A6.14.2 Controls

- (a) Any truck parked on a property in a rural area must only be used in association with an approved rural, agricultural, or rural industrial land use legally carried out on that property.
- (b) No truck that is used for a business unrelated to the rural property; contracted bulk haulage, excavation or demolition work may be permanently parked on a rural property. Such trucks are to be parked in an approved, legally operating truck depot as defined under WLEP 2010.
- (c) No truck used for an activity involving hazardous or dangerous goods may be parked on a rural property.
- (d) No truck used for any purpose which may be reasonably expected to cause interference to amenity in terms of dust, fumes, odour, waste products etc as a result of the truck being parked in that area may be parked on a rural property.
- (e) When not in use no truck shall be parked within 100m from any residential building or habitable building on any adjoining property.
- (f) Trucks must not be cleaned on site.

A6.15 Airstrips and Helipads

Airstrips and helipads are permissible with consent in the zones to which this Plan applies. Applicants should liaise with Council and relevant government departments and agencies to ensure all current recommended practices are employed.

Under WLEP 2010, Airstrip means “a single runway for the landing, taking off or parking of aeroplanes for private aviation only, but does not include an airport, heliport or helipad.”

Under WLEP 2010, Helipad means “a place not open to the public used for the taking off and landing of helicopters.”

In assessing an application for an airstrip or heliport Council will consider the cumulative effects of such facilities in rural areas.

SECTION 6 ADDITIONAL CONTROLS

A6.15.1 Objectives

In assessing an application for an airstrip or helipad Council will consider the extent to which the following objectives are addressed by the applicant.

- (a) The location and construction of the airstrip or helipad shall be to the standards required by regulatory authorities to ensure the safety of users and neighbours.
- (b) The proposal will not have a detrimental effect on the rural landscape within which it is located.
- (c) The proposal will not have a detrimental effect on neighbouring properties with regard to noise or visual impact.
- (d) The proposal will not have a detrimental effect on the surrounding environment or the environment over which the aeroplane or helicopter passes.

A6.15.2 Controls

- (a) Applicants must contact relevant government agencies to ensure a workable and safe airstrip or helipad is constructed.
- (b) Applications shall include a site plan and statement of environmental effects clearly showing:
 - (i) Location in relation to scenic impact, impact on wildlife habitats and corridors.
 - (ii) Gradient and slope of site,
 - (iii) impact on the environment
 - (iv) visual impact (both on and off site),
 - (v) associated erosion and any remediation measures
 - (vi) Information on the type and construction material proposed
 - (vii) Information on the volume of traffic.
 - (viii) Information on all possible approaches used for landing and the impacts on adjoining owners
 - (ix) An acoustic report

SECTION 6 ADDITIONAL CONTROLS

A6.16 Wind Turbines

At the time of writing, it is the Department of Planning's intention to amend the State Environmental Planning Policy (Infrastructure) 2007 ("the Infrastructure SEPP") to include certain types of small-scale wind turbines in the zones to which this Plan applies as either exempt or complying development.

A small wind turbine is defined as having a rated capacity of less than 10kW. These turbines can be connected to the grid via an inverter, but more commonly are used to generate electricity as 'stand-alone' or 'off grid' power supply systems. Small wind turbines may be free-standing, or mounted on a building or other structure.

Wind turbines which do not qualify for exempt or complying development are permissible with consent in the zones to which this Plan applies.

In all cases, Council's main concerns relate to noise and visual intrusion into the rural landscape. With regard to noise, the technology of wind turbines continues to evolve and applicants should pay particular attention to the noise and vibration produced by blades, gears and motors. Some small wind turbines can be noisy at medium to high wind speeds.

Council understands that wind turbines need to be located in prominent positions and this can have detrimental visual impacts on the landscape. Development that requires Council approval will be assessed on its merits with particular reference to the site analysis required as indicated in Section A3.3 of the Plan. Where more than one turbine is proposed, a clustering of turbines would generally be preferred to stringing them out along a prominent ridge-line.

Applications for wind generation proposals which are of a large-scale or for commercial purposes will also be assessed by Council on their merits. While Council is supportive of alternative energies, it needs to assess the environmental impacts of a large scale commercial development against some assessment of the potential efficacy of such a 'wind farm' proposal. Such an assessment would include noise and visual impacts, any potential hazard to flying birds, and the need for vegetation clearing and tree removal.

Should a large scale development be supported by Council, one requirement will be that if the development ceases to operate, the turbines be removed from the site.

A6.16.1 Exempt Development

The following small wind turbines shall qualify as Exempt Development, provided the development:

- (a) is located on land that is zoned for rural purposes (i.e. RU1 Primary Production or RU2 Rural Landscape for the purposes of this DCP).

SECTION 6 ADDITIONAL CONTROLS

- (b) has a generating capacity of less than 10 kW.
- (c) is set back from the nearest, non-associated dwelling by at least 200 metres.
- (d) is free standing and not relying on other structures for support.
- (e) is less than 25 metres in height (including blade tip height).
- (f) is limited to one turbine per lot and no other existing wind turbines are installed on the lot.
- (g) is clear from power lines in accordance with the requirements of the relevant electricity authority.
- (h) does not involve the removal or pruning of a tree or other vegetation that requires a permit or development consent for removal or pruning, unless that removal or pruning is undertaken in accordance with a permit or development consent.
- (i) is installed in accordance with the manufacturer's specifications.

A6.16.2 Complying Development - Free standing wind turbines

Free standing wind turbines mounted on the ground with a peak generating capacity of less than 10kW shall qualify as Complying Development, provided:

- (a) If located in the RU1 or RU2 zone, they are:
 - (i) less than 25 metres in height (including blade tip height), and
 - (ii) the combined installed wind turbine generating capacity is less than 60kW including any existing installed wind turbine capacity,
- (b) If located in the E3 or SP3 zone, they are:
 - (i) less than 18 metres in height (including blade tip height), and
 - (ii) the combined installed wind turbine generating capacity is less than 60kW including any existing installed wind turbine capacity.
- (c) In all zones, each wind turbine is set back from the nearest, non-associated dwelling by at least:
 - (i) 25 metres where the turbine has a sound power level of 0-70 dB(A), or
 - (ii) 40 metres where the turbine has a sound power level of 70-80 dB(A), or
 - (iii) 126 metres where the turbine has a sound power level of 80-90 dB(A), or
 - (iv) 200 metres where the turbine has a sound power level of more than 90 dB(A).

SECTION 6 ADDITIONAL CONTROLS

In all cases, the sound power level value shall be specified by an independent testing laboratory at a wind speed of 8 metres per second in accordance with the international standard IEC 61400-11 Noise Measurement.

Note. The noise a wind turbine creates is normally expressed in terms of its sound power level. Each turbine has its own sound power level, which remains constant for that turbine at any given wind speed. Sound power levels specified by independent testing bodies are freely and readily available for most wind turbines available in the Australian market. Examples of independent testing bodies include (but are not limited to) the Research Institute for Sustainable Energy (RISE) at Murdoch University in South Australia, National Renewable Energy Laboratory (NREL) in the United States, and TUV NEL in the United Kingdom, CIEMAT in Spain.

- (d) In all zones, each wind turbine:
 - (i) is clear from power lines in accordance with the requirements of the relevant electricity authority.
 - (ii) is not located on land on which a building that is a State or local heritage item is located or is in a heritage conservation area.
 - (iii) does not involve the removal or pruning of a tree or other vegetation that requires a permit or development consent for removal or pruning, unless that removal or pruning is undertaken in accordance with a permit or development consent.
 - (iv) is installed in accordance with the manufacturer's specifications.

A6.16.3 Complying Development - Wind turbines mounted on a building or structure

Wind turbines mounted on a building or structure with a peak generating capacity of less than 10kW shall qualify as Complying Development, provided:

- (a) the combined installed wind turbine generating capacity is less than 60kW including any existing installed wind turbine capacity, and
- (b) each wind turbine is setback from the nearest, non-associated dwelling by at least:
 - (i) 25 metres where the turbine has a sound power level of 0-70 dB(A), or
 - (ii) 40 metres where the turbine has a sound power level of 70-80 dB(A), or
 - (iii) 126 metres where the turbine has a sound power level of 80-90 dB(A), or

SECTION 6 ADDITIONAL CONTROLS

- (iv) 200 metres where the turbine has a sound power level of more than 90 dB(A), or

where the sound power level value is specified by an independent testing laboratory at a wind speed of 8 metres per second in accordance with the international standard IEC 61400-11 Noise Measurement.

Note. The noise a wind turbine creates is normally expressed in terms of its sound power level. Each turbine has its own sound power level, which remains constant for that turbine at any given wind speed. Sound power levels specified by independent testing bodies are freely and readily available for most wind turbines available in the Australian market. Examples of independent testing bodies include (but are not limited to) the Research Institute for Sustainable Energy (RISE) at Murdoch University in South Australia, National Renewable Energy Laboratory (NREL) in the United States, and TUV NEL in the United Kingdom, CIEMAT in Spain.

- (c) each wind turbine:
 - (i) does not protrude more than 3 metres above the highest point of the existing roof line.
 - (ii) does not involve the removal or pruning of a tree or other vegetation that requires a permit or development consent for removal or pruning, unless that removal or pruning is undertaken in accordance with a permit or development consent.
 - (iii) is clear from power lines in accordance with the requirements of the relevant electricity authority.
 - (iv) does not affect the structural integrity of the building.
 - (v) is not located on land on which a building that is a State or local heritage item is located or is in a heritage conservation area.
 - (vi) is installed in accordance with the manufacturer's specifications.

A6.16.4 Assessment of Wind Turbine Developments where Consent is Required.

Where a proposed development for the purposes of wind energy generation does not fall into the category of either exempt or complying development, the following controls shall apply.

- (a) Siting of the development shall be considered on merit, taking into account the topography, vegetation and other relevant characteristics of the site as supplied in the Site Analysis report as required in Section A3.3 of this Plan.
- (b) Where more than one turbine is proposed, preference shall be given to the clustering of turbines, rather than to their scattering across the landscape.

SECTION 6 ADDITIONAL CONTROLS

- (c) A noise study is to be supplied by the applicant, as required by Council.
- (d) A Heritage Impact Statement is required if the proposal is considered by Council to be within the immediate visual catchment of an item or Place considered by Council to be of heritage significance. Proposals involving Items or Places of Heritage shall be assessed by Council on their merits.
- (e) Only domestic scale proposals will be considered in a designated Wildlife Corridor. Commercial facilities shall be prohibited in such a Corridor. No wind generation facility shall be permitted within a designated Corridor which is particularly important as an identified bird migration route.

A6.17 Signage**A6.17.1 Introduction**

There can be several purposes for signage in rural areas. They can show property names, advertise ancillary commercial activity, such as Bed and Breakfast Establishments or farm-gate locations, or provide directions to rural enterprises such as wineries.

A6.17.2 Objectives

The objectives for all signage (whether requiring consent or not) in the rural areas are that such signage:

- (a) is compatible with the desired amenity and visual character of the area.
- (b) provides effective communication in suitable locations.
- (c) shall not be confused with or inhibit instructions given by official traffic management facilities and signs.
- (d) shall not affect the amenity of an area due to their size appearance, content or placement.
- (e) shall not interfere with the visual prominence of any key features in the rural landscape, including any views and vistas.

A6.17.3 Controls

To meet these objectives, all permissible signage shall comply with the following controls:

- (a) The location and design of signage shall not interfere with or adversely impact on any landscape elements, including topography, ridgelines, significant vegetation, farm buildings, roads and gateways.
- (b) Signs shall be located so as not to cause any visual obstruction to vehicular or pedestrian traffic.
- (c) The design and selection of colours and materials of signs must relate to the existing palette of colours in the rural landscape.

SECTION 6 ADDITIONAL CONTROLS

- (d) All signage must be designed and finished to a high quality.
- (e) Signs shall be assessed as to their cumulative effect to avoid proliferation and visual confusion that would detract from the character of the rural landscape. Where appropriate, integrated signage on behalf of several businesses or properties may be suggested.
- (f) Council may issue time limited consents for certain types of signage
- (g) Signs seeking the consent of Council may only be sited on the land to which the advertised activity or destination applies.
- (h) No signs shall be painted directly on to the building façade, with the exception of listed items of Environmental Heritage.
- (i) The following signs are prohibited in rural areas:
 - (i) Any 'off-site' signage; including any signage not directly relating to the property on which it is placed, advertising attached to trailers / motor vehicles etc parked on a road or reserve for more than one day in any one month period.
 - (ii) Advertising objects such as inflatable objects.
 - (iii) Bunting and Flags (with the exception of recognised Australian flags and / or recognised civic service flag.
 - (iv) No buildings painted wholly or substantially in corporate colours.

A6.17.4 Council Approval for Signage

The following sub-section identifies those forms of signage which do NOT require approval for Council. If your proposed sign exceeds any of the standards listed below, a Development Application must be lodged with Council. The Application must include a copy of the proposed art work for the sign as well as details of the dimensions of the proposed sign and a diagrammatic indication of the proposed location of the sign.

A6.17.5 Signage for which no Development Application is required

Council consent is **NOT** required for the following forms of signage as described below, **unless:**

- a) It is to be located on an Item of Heritage or draft Item of Heritage or in a Heritage Conservation or draft Heritage Conservation Area. ('Heritage' applies to Archaeological, General or Landscape heritage).
- b) It does not comply with the Objectives and General Requirements sections above

SECTION 6 ADDITIONAL CONTROLS

- c) It does not comply with any of the following sign-specific standards.

If a sign does not meet the requirements of (a), (b) or (c) above, Council approval is required.

Further details on Signage requiring Council consent are contained below.

A6.17.6 Advertising structures and the display of an advertisement on it or the display of an advertisement that is not affixed to an advertising structure, being a sign that displays an advertisement that relates to the premises on which it is situated

Advertising structures shall be permitted without consent provided they comply with all of the following controls. If not, a development application will be required.

- a) Sign must not cover mechanical ventilation inlet or outlet vents.
- b) Advertisement must relate to an approved use carried out on the land.
- c) Signs that have red, amber, green or blue lighting must not be erected near traffic control signals.

A6.17.7 Building Identification Signs

Building identification signs identify or name the building and are located on the building facade. Building Identification Signs shall be permitted without consent provided they comply with all of the following controls. If not, a development application will be required.

- a) Only one (1) sign per street frontage
- b) Sign must not be more than 2.5m² in area
- c) Sign must be mounted flat against the exterior wall or parapet and not protrude more than 300mm from the face of the building
- d) If illuminated, must comply with illumination controls in 10.4 (General Requirements for all Signage) above.

A6.17.8 Business Identification Signs in a Rural or Environmental Protection zone

Business identification Signs shall be permitted without consent provided they comply with all of the following controls. If not, a development application will be required.

- a) One sign per premises.

SECTION 6 ADDITIONAL CONTROLS

- b) If a sign for the purposes of a home business, home industry or home occupation, a maximum size of 1m² is permitted
- c) If a sign for a purpose other than home business, home industry or home occupation, a maximum size of 2.5m² is permitted
- d) Must not be illuminated.
- e) Located wholly within property boundaries of the land to which the sign relates, or is flush mounted to the front fence or front wall of a building as long as the sign does not protrude beyond the physical limits of that fence or building.
- f) If a window sign for the purposes of a home business, home industry or home occupation, maximum size limited to 20% of the window surface or 6m², whichever is the smaller.

A6.17.9 Directional signs, name plates, advance traffic warning signs, community Information signs and law enforcement signs erected by the council or other public authorities

- a) Signs erected over a public road shall be permitted without consent provided that area at least 0.6m from the vertical projection of the kerb line, and suspended at least 2.6m above existing ground level. Otherwise, a development application will be required.

A6.17.10 Property address signs

Property Address Signs shall be permitted without consent provided they comply with all of the following controls. If not, a development application will be required.

- a) One sign per premises.
- b) Maximum size of 1m² in residential zones and 1.5m² in all other zones.
- c) Maximum height of 1.8m in residential, rural or environmental protection zones.
- d) Must not be illuminated in residential, rural or environmental protection zones.
- e) Must be located wholly within property boundaries of the land to which the sign relates, or flush mounted to the front fence or front wall of a building as long as the sign does not protrude beyond the physical limits of that fence or building.

A6.17.11 School signs

School Signs shall be permitted without consent provided they comply with all of the following controls. If not, a development application will be required.

- a) Maximum 3 signs per street frontage.
- b) Located wholly within the school boundaries.

SECTION 6 ADDITIONAL CONTROLS

- c) Must be ancillary to the school.
- d) Maximum size of 0.75 m².
- e) Minimum distance apart of 3.5m.
- f) Maximum height to top of sign of 1.5m above existing ground level.

A6.17.12 Real estate signs, advertising that the premises on which they are displayed are for sale or lease

Real Estate Signs shall be permitted without consent provided they comply with all of the following controls. If not, a development application will be required.

- a) Must be located wholly within the property boundaries of the land to which the sign relates, or if on the footpath, must be flush against the property boundary
- b) Must not be erected on public land
- c) Must not be attached to the building if an Item of Heritage or draft Item of Heritage
- d) Maximum of two (2) signs per premises in Residential zones with a combined total surface area of 3m²
- e) Maximum size in Business or Industrial zones of 4.5m² for lots comprising 1-9 dwellings, or 10m² for sites with more than 10 lots.
- f) Maximum size in Environmental Protection zones of 1.5m²
- g) No higher than 5m above existing ground level
- h) Must not be illuminated
- i) For lots comprising 1-9 dwellings, signs must be removed within fourteen (14) days of the final sale transaction, or before construction starts on the land
- j) For sites with more than 10 lots, signs shall be removed when 80% of lots are sold, or by the end of two (2) years
- k) Temporary Open for Inspection or Open House signs are permitted, but must be removed on the day of opening

A6.17.13 Community Notice and Public Information Signs

Community Notice and Public Information Signs is a sign providing information on, or advertising services or activities on a site for, a public or community institution or organisation and shall be permitted without consent provided they comply with all of the following controls. If not, a development application will be required.

- a) There is only one (1) sign facing any road frontage
- b) Maximum area of sign is 3.5m²
- c) The sign is no higher than 5m above existing ground level

SECTION 6 ADDITIONAL CONTROLS

- d) The sign is wholly located within the boundaries of the site
- e) The sign is not illuminated

A6.17.14 Display Flags, Bunting and Site Boundary Wraps

Display flags, bunting and site boundary wraps shall be permitted without consent provided they comply with all of the following controls. If not, a development application will be required. Council will consider proposals for advertising flags in lieu of other types of signs in Business zones, and such will be considered on their individual merits and must satisfy the objectives for this section of the DCP.

- a) Display flags, bunting and site boundary wraps used for advertising in business areas shall not be additional to the maximum number of signs permissible under this Plan, i.e. if an applicant seeks approval for an above awning sign and bunting/flag(s)/site wrap, Council will not consent to both types of signage as it would exceed the intended number of signs for that circumstance.
- b) Bunting on the boundary of a property during construction shall be approved by Council and be maintained at all times in a neat and tidy condition.

A6.17.15 Temporary Event Signs or Banners

Temporary Event Signs or Banners advertising a commercial, community or retail event or a private function (including sponsorship of the event or function) shall be permitted without consent provided they comply with all of the following controls. If not, a development application will be required.

- a) not result in more than one banner and one other type of temporary sign facing any road frontage, and
- b) not have a surface area of more than 6m², and
- c) be located wholly within the boundaries of the property or, if attached to a building, fence or wall, not project more than 100mm from the building, fence or wall, and
- d) not be higher than 5m above ground level (existing), and
- e) not be permanently fixed to a building, fence or wall, and
- f) if advertising a commercial or retail event,
 - (i) not be located in a residential zone, and
 - (ii) not be illuminated, and
 - (iii) not be displayed earlier than 14 days before the event, and
 - (iv) be removed within 2 days after the event.
- g) not be a 'fly' poster taped to poles, hoardings or buildings.

SECTION 6 ADDITIONAL CONTROLS

A6.17.16 Election Signs

The display of any poster that contains electoral matters is permitted without consent provided the signs only cover electoral matters and show the name of the candidate and the party as well as a picture of the candidate and meet the following controls. If not, a development application will be required.

- a) Be erected not more than 28 days before polling day
- b) be removed within one (1) week of polling day
- c) not be affixed to power or street light poles
- d) not be erected on public land such as parks, pedestrian areas, footpaths or public buildings

A6.18 Signage as Complying Development

NB: Development under the *Part 5 (Commercial and Industrial Alterations Code) of the Exempt and Complying Development Codes 2008*, for projecting wall signs and freestanding pylon and directory board signs can only be carried out on land that is in a Business (B), Industrial (I) or Special Purpose (SP) zone. The *Exempt and Complying Development Codes 2008* should also be consulted for general Development Standards for Signage.

A6.19 Signage requiring Council Consent

If the proposed Signage is not Exempt or Complying development, a Development Application must be lodged with Council. The Application must include, at least:

- a) a copy of the proposed art work for the sign
- b) details of the dimensions of the proposed sign
- c) a diagrammatic indication of the proposed location of the sign.

As stated in the Introduction to this Chapter, all Development Applications for Signage or Outdoor Advertising for which Council consent is required will be assessed against the criteria contained within *State Environmental Planning Policy No. 64 – Advertising and Signage (SEPP 64)*. These criteria address the general character and sensitivities of the locality, impacts on streetscape, views and vistas, appropriateness of the sign to the building on which it is to be located and any relevant safety aspects.

A6.19.1 Assessment Criteria for all Signage requiring Council Consent Including Digital Signage)**10.6.1.1 Character of the area**

- Is the proposal compatible with the existing or desired future character of the area or locality in which it is proposed to be located?
- Is the proposal consistent with a particular theme for outdoor advertising in the area or locality?

SECTION 6 ADDITIONAL CONTROLS

10.6.1.2 Special areas

- Does the proposal detract from the amenity or visual quality of any environmentally sensitive areas, heritage areas, natural or other conservation areas, open space areas, waterways, rural landscapes or residential areas?

10.6.1.3 Views and vistas

- Does the proposal obscure or compromise important views?
- Does the proposal dominate the skyline and reduce the quality of vistas?
- Does the proposal respect the viewing rights of other advertisers?

10.6.1.4 Streetscape, setting or landscape

- Is the scale, proportion and form appropriate for the streetscape, setting or landscape?
- Does the proposal contribute to the visual interest of the streetscape, setting or landscape?
- Does the proposal reduce clutter by rationalising and simplifying existing advertising?
- Does the proposal screen unsightliness?
- Does the proposal protrude above buildings, structures or tree canopies in the area or locality?
- Does the proposal require ongoing vegetation management?

10.6.1.5 Site and building

- Is the proposal compatible with the scale, proportion and other characteristics of the site or building, or both, on which the proposed signage is to be located?
- Does the proposal respect important features of the site or building, or both?
- Does the proposal show innovation and imagination in its relationship to the site or building?

10.6.1.6 Associated devices and logos with advertisements and advertising structures

- Have any safety devices, platforms, lighting devices or logos been designed as an integral part of the signage or structure on which it is to be displayed?

10.6.1.7 Illumination

- Would illumination result in unacceptable glare?
- Would illumination affect safety for pedestrians, vehicles or aircraft?
- Would illumination detract from the amenity of any residence or other form of accommodation?
- Can the intensity of the illumination be adjusted, if necessary?
- Is the illumination subject to a curfew?

SECTION 6 ADDITIONAL CONTROLS

A6.19.2 A10.6.2.3 Corporate Signage

Council respects the right for a business with corporate logos and/or colours to use them. However, Council also retains the right to determine the size and location of such signage. Corporate colours and graphics are intended to draw attention to the business and usually comprise bright colours and graphics. These can often be in stark contrast to existing older signage and can impact on the overall character of a business area.

Applications using corporate signage which exceeds the Exempt or Complying Development maximum standards will require Council consent.

In addition to the general objectives, guidelines and assessment criteria contained in this Section of the Plan, Business Identification Signs utilising corporate graphics and colours shall be assessed to determine an appropriate size taking into consideration the following:

- (a) Whether the sign is to be located on an Item or Draft item of Heritage, or within a Heritage or Draft Heritage Conservation Area.
- (b) The dominance of the corporate graphics and colours on the streetscape.
- (c) The age and style of the building and the appropriateness of the sign on the building
- (d) The style and size and of existing signage in the vicinity of the proposed sign
- (e) Where the sign is to be mounted on a wall, fascia or parapet, the size of the sign will be limited. The tradition of indenting and area on a parapet for a Building Identification Sign provides a useful guide as to the proportion of such an area which could be allocated to a Business Identification Sign.
- (f) Where such an indentation exists, the Business Identification Sign will be limited to that indented area.
- (g) Where there is no indentation, the size and scale of the sign will reflect the result which would be achieved if an indented area were used.

A6.20 Digital Signage

Digital signs are devices which use digital technology to display bright, high quality electronic images. A central feature of these devices is the use of Light Emitting Diode (LED) technology allowing luminance to be controlled and adjusted automatically. (*Transport Corridor Outdoor Advertising & Signage Guidelines – Department of Planning & Environment, November 2017*).

Variable Message Signs (VMSs) are a form of Digital signage, commonly seen in the context of trailer-mounted road side signage.

Digital signs, other than a Variable Message Sign, are prohibited in the rural and environmental protection zones.

SECTION 6 ADDITIONAL CONTROLS

A6.20.1 Variable Message Signs

A Variable Message Sign (VMS) is prohibited in all zones unless it:

- a) Meets the Signage Objectives and General Requirements of this Section, and
- b) contains information that pertains only to a public or community event, or for road works or emergency services purposes in compliance with Australian Standard AS1742.3.
- c) except for the purposes of a Council run event, it is wholly located on privately owned land, and the owner of the land provides written authority for a Development Application for a VMS on the subject land to be lodged and assessed by Council, and
- d) if located where SEPP 64 applies, complies with any additional controls which the SEPP imposes.

A10.7.1.2 Assessment

If a VMS is permissible with Council consent, it will be assessed in accordance with Section 3.2.2 of the NSW Department of Planning and Environment's document *Transport Corridor Outdoor Advertising and Signage Guidelines, 2017*.

An application for a Variable Message Sign shall comply with the following controls applicable under SEPP 64:

- a) The speed limit of the road on which the VMS is located is not be greater than 70 kilometres per hour
- b) The display change frequency rate (dwell time) on a dynamic display shall be no faster than 3 seconds.
- c) The display remains completely static from between change intervals.
- d) The level of illumination automatically adjusts according to ambient light levels.
- e) The sign does not contain any scrolling messages (i.e. displayed text or graphics which moves up, down or across the screen so that a line of text or graphics appears at one edge of the screen for each line that moves off the opposite edge).

A6.21 Replacement of Existing Signage

The replacement of existing signage does not require Council consent provided it will:

- a) Replace only an existing lawful sign
- b) Be exactly the same size as the existing sign
- c) Not change the structure of vessel on which the sign is attached
- d) Not block or interfere with traffic signs



Section 7 Development Near Rail Corridors & Busy Roads

This section applies to development on land which is adjacent to a rail corridor or a busy road corridor. The contents of the Department of Planning's document "Development near Rail Corridors and Busy Roads – Interim Guideline" (which may be viewed at the Customer Services Counter of Wingecarribee Shire Council) must be consulted.

A7.1 Development Adjacent to a Rail Corridor

A7.1.1 Controls

- (f) The protection of the stability of the nearby rail corridor and railway land during excavation and construction of any development must be ensured.
- (g) Any excavation greater than 2m in depth and within 25 metres of the rail corridor will require concurrence with the relevant authority under clause 86 of SEPP (Infrastructure) 2007.
- (h) Drainage from the development is to be adequately disposed of so as not to be diverted on to the rail corridor.
- (i) Appropriate fencing is to be constructed to clearly separate the development from the railway land so as to avoid people straying on to railway land, either during construction or following completion of the development.
- (j) Appropriate landscaping and fencing is to be installed to screen and soften views of the rail tracks from the development and to help alleviate the 'sense' of exposure of the development to the source of rail noise.

A7.1.2 Introduction

Council will require concurrence from the relevant regulatory authority for several roads across the zones covered by this DCP. Generally, access to development from these roads is not encouraged and will be limited to existing access points only. It should be noted, however, that even existing access arrangements may be reviewed in light of certain redevelopment proposals.

Land Use Applications involving land fronting state authority regulated roads need to comply with the following controls.



A7.1.3 Controls

Council shall not grant consent to the carrying out of development on any land to which this Clause applies unless it is satisfied that adequate provision has been made to ensure that such development:

- a) avoids any new direct vehicular access to any relevant road and removes any existing access where alternative rear lane or other access is achievable.
- b) provides that any essential access to any relevant road be designed so that all vehicles enter and leave the site in a forward direction.
- c) restricts vehicular access, car parking and loading/unloading facilities to an alternative access, such as a rear lane, where such access is available.
- d) makes an appropriate Section 94 developer contribution towards the provision of public car parking where only a single frontage to a relevant road is available.

Section 8 Heritage and Landscape Conservation

A8.1 Introduction

There are a number of heritage items and heritage conservation areas in the Wingecarribee Shire. The majority of these are within the established towns and villages. However, there are many heritage items and four conservation areas (including two landscape conservation areas) in rural locations.

Heritage items and heritage conservation areas are listed in Schedule 5 of the WLEP 2010 and the location of each shown on the Heritage Maps that accompany WLEP 2010.

The location of the four heritage conservation areas applicable in this DCP (namely the Berrima Landscape Conservation Area, the Burradoo Landscape Conservation Area, the Joadja Conservation Area, and the Throsby Park Conservation Area) are reproduced in [Figures A8.1 and A8.2](#) below.

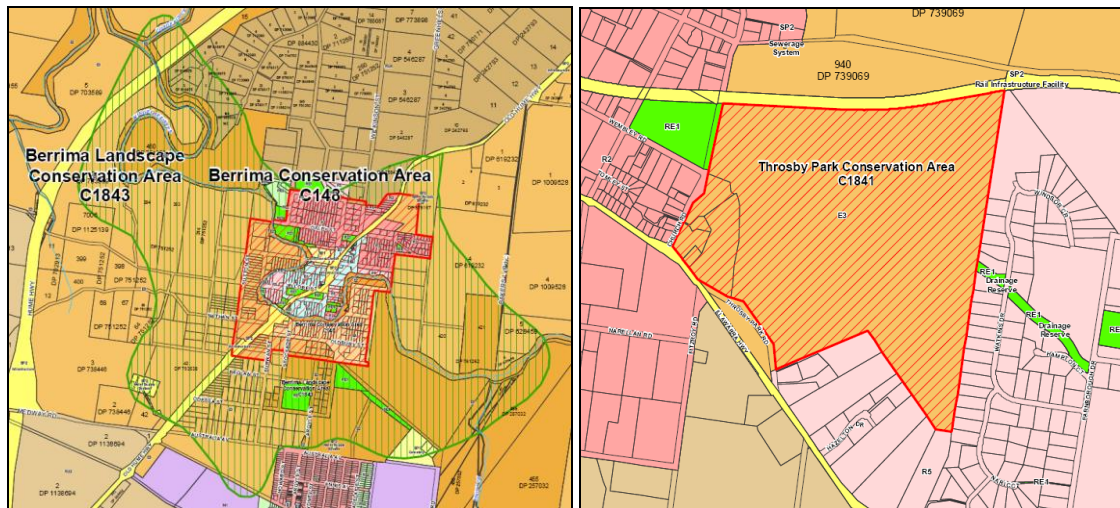

Figure A8.1 – Berrima (left) & Throsby Park (right) Conservation Areas

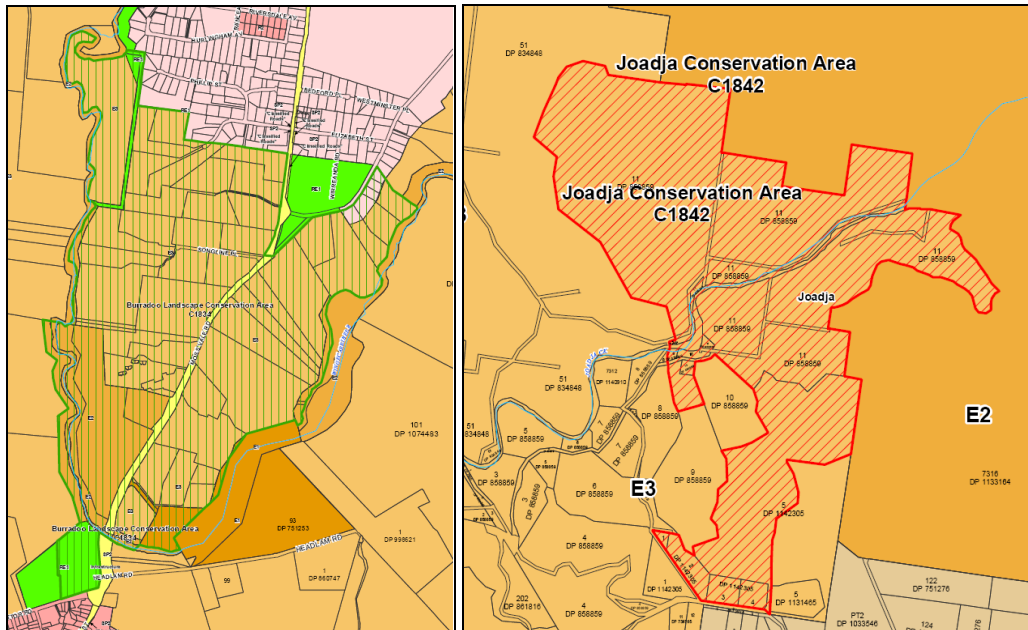

Figure A8.2 – Burradoo (left) & Joadja (right) Conservation Areas

Note: Applicants should not rely on the printed version of this or any other map in this document for current zoning or other planning information, but should consult the Wingecarribee LEP 2010 maps which may be accessed from Council’s website, www.wsc.nsw.gov.au.

Note: Please refer to the Berrima Village Development Control Plan for information and controls that apply to the Berrima Conservation Area, shown hatched red on [Figure A7.1](#) above.

This section applies to development within or adjacent to heritage items and the abovementioned heritage conservation areas within the rural areas to which this DCP applies.

A8.2 General Objectives

Applicants are directed to the provisions of Clause 5.10 of WLEP 2010 which relate to the conservation of Items of Heritage and Heritage Conservation Areas and also to the associated Schedule 5. Except for minor works as defined in clause 5.10(3), this clause requires development consent for any of the following within heritage items and heritage conservation areas:

- (a) demolition



- (b) alteration of any building, work, relic, tree or place (this includes removal of trees and vegetation which may be important to the visual setting of the conservation area).
- (c) erection of a building or buildings, or
- (d) subdivision.

Council is committed to ensuring that all future development on heritage items and within conservation areas is appropriate with regard to the following objectives:

- (a) Preserve and protect buildings, areas and vistas of heritage and cultural value.
- (b) To ensure that all new development within the Heritage Conservation Areas is compatible with the existing visual, built and landscape character of the area by setting standards which will ensure this.
- (c) To encourage increased community awareness of the intrinsic heritage, visual and environmental qualities of the heritage and landscape conservation areas within the rural zones and the need for conservation measures. In particular, the need to ensure that owners are aware of the responsibilities associated with the ownership and maintenance of heritage listed properties.
- (d) Ensure that redevelopment immediately adjacent to buildings of heritage or cultural value in no way detracts from the visual quality or amenity of heritage buildings.
- (e) Ensure that redevelopment within or immediately adjacent to conservation areas reflects the high heritage value and visual setting of the area and contributes to that value.

A8.3 Alterations to and Restoration of Heritage Items and Draft Heritage Items

Heritage Items are identified in Schedule 5 of WLEP 2010 and applicants are directed to this Schedule and to the provisions of clause 5.10 of the LEP regarding Heritage Conservation in general. Draft heritage items are those that are proposed heritage items contained within a draft amendment to WLEP 2010 that has been on formal public exhibition in accordance with the provisions of section 57 of the Environmental Planning and Assessment Act 1979.

A8.3.1 Objectives

- (a) To retain heritage values of heritage listed items.
- (b) To protect the heritage significance of draft heritage items.



A8.3.2 Controls

- (a) Development applications on properties containing listed heritage items or draft heritage items shall be referred to the Council Heritage Adviser for comment prior to lodgement of the development application.
- (b) Development applications on a property on the NSW State Heritage Register or National Heritage Register items shall be referred to the NSW Heritage Council for comment prior to lodgement of the development application. The NSW Heritage Council is the approval authority for such applications. Details of any comments provided shall be included in the statement of environmental effects submitted with the development application to Council.
- (c) Development applications on properties containing listed heritage items or draft heritage items shall contain a Heritage Impact Statement (or Heritage Conservation Strategy or Heritage Conservation Plan as requested by Council).
- (d) All development applications containing listed heritage items or draft heritage items should be notified by Council to Council's Heritage Advisory Working Group and the Berrima Residents Association for comment.
- (e) In considering whether to grant consent to a development proposal on properties containing listed heritage items or draft heritage items, Council must be satisfied that the proposal:
 - (i) Is sympathetic to the retained elements of the Heritage Item and its setting in terms of setback, scale, building design and form, materials, proportion and spacing of openings, to achieve a subtle contrast between old elements and new.
 - (ii) Retains as much of the existing building fabric as is possible, particularly those elements which contribute towards the building's visual/heritage significance.
 - (iii) Minimises the modification to original door or window openings, spacings and proportions.
 - (iv) Removes any unsympathetic building elements, additions or accretions.
 - (v) Reinstates the original façades and architectural elements. (The original existence of such elements must be demonstrated by empirical research which shall be included as part of the development application.)



- (vi) Retains natural surface finishes, or applies colour schemes for external painting which reflect the relevant period. Cladding with modern finishes is not permitted.
 - (vii) Ensures building additions are sympathetic to the item and its setting in terms of setback; scale; building design and form; materials; proportion and spacing of openings, and achieve a subtle contrast between old and new.
 - (viii) Ensures important elements of garden and landscape are identified and protected.
- (f) Where subdivision is proposed, ensure that an appropriate curtilage area is identified and retained.

A8.4 Development in the vicinity of Heritage Items

A8.4.1 Objective

To retain heritage values of listed heritage items and draft heritage items by ensuring that development in the vicinity is sympathetic with the heritage values of individual items and to any applicable heritage conservation area.

A8.4.2 Controls

- (a) Development applications on properties containing or adjoining locally listed items or draft heritage items shall be referred to the Council Heritage Adviser for comment prior to lodgement of the development application.
- (b) Development applications adjoining or in the vicinity of a property on the NSW State Heritage Register or National Heritage Register shall be referred to the NSW Heritage Council for comment prior to lodgement of the development application. Details of any comments provided shall be included in the statement of environmental effects submitted with the development application to Council.
- (c) Development applications on properties adjoining listed heritage items or draft heritage items shall contain a Heritage Impact Statement (or Heritage Conservation Strategy or Heritage Conservation Plan as requested by Council).
- (d) Development applications on properties in the vicinity of any heritage listed item or draft heritage item, including within sight of and adjacent to any heritage item or draft heritage item, should be referred to Council's Heritage Adviser for comment.



Note: Development applications adjoining or in the vicinity of a property on the NSW State Heritage Register or National Heritage Register items should be referred to the NSW Heritage Council for comment prior to lodgement of the Development Application.

- (e) All development applications on properties in the vicinity of any listed heritage item or draft heritage item should be notified by Council to Council's Heritage Advisory Working Group for comment.

A8.5 Alterations and New Development in Heritage Conservation Areas

The important element with all of the rural heritage conservation areas is not the buildings themselves so much as the separations between buildings and the treatment of the spaces between. This includes trees, shrubs and other landscaping elements.

A8.5.1 Objective

To retain the rural and historic setting of the rural heritage conservation areas by ensuring that new development is appropriately located.

A8.5.2 Controls

- (a) Enhance landscaping with a thematic use of plant species and styles (i.e. identify common local plant varieties, use of hedges etc.).
- (b) Avoid large scale monolithic buildings and achieve small scale and discreet built forms.
- (c) No fencing is to be erected that would, in the opinion of Council, have a detrimental impact on the rural bushland setting of the conservation area or of any listed heritage item. All fences require Council consent, except for traditional rural fences of wire or wire mesh or of timber post and rail design to a maximum height of 1400mm and in a natural timber or dark colour.
- (d) A landscape plan is required for all plantings that are expected to reach a mature height of greater than 1000mm.
- (e) In addition to the above controls, any specific development controls for the particular heritage conservation area shall apply.

A8.6 Berrima Landscape Conservation Area

A8.6.1 Description

The Berrima Landscape Conservation Area surrounds the historic village of Berrima and defines its visual catchment. This visual catchment area, delineated in 1977 by the



National Trust of Australia (NSW) in a study that recommended planning guidelines for the Village, maps the visual boundaries of the Village. The Trust concluded that the village's character of open farm land, mixed with natural bush, is crucial to Berrima's setting and its heritage character of an early Australian country town contained within a confined hollow with little development visible from the village itself or its approaches.

A8.6.2 Objectives

The objectives for the Berrima Landscape Conservation Area are to:

- (a) Retain and conserve the intrinsic features of Berrima Village's existing visual, built and landscape character and its visual catchment area.
- (b) Retain the rural ambience arising from the natural landscape surrounding the village with minimal number of buildings visible from the main approaches to Berrima.
- (c) Retain the open setting along the main approaches to and exits from Berrima, being the Old Hume Highway (Great South Road), Oldbury Street, Berrima Road (to the southern boundary of the Berrima cemetery) and Medway Road (between the Old Hume Highway and the freeway).
- (d) To minimise the population pressures on the village by retaining the undeveloped nature of the Berrima Landscape Conservation Area and strictly enforcing its protective zoning.
- (e) To encourage the use of the roads and 'paper' roads within the Berrima Landscape Conservation Area as habitat corridors.

A8.6.3 Understanding the Georgian Style

Georgian style houses displayed symmetry, spatial separation, small-scale pitched roofs and traditional proportions for windows and doors. Australian additions to the style were verandahs and galvanised roofs. New residential development in Berrima has followed the Georgian style template in a dispersed village. Berrima has benefited from this very sympathetic development.

Architects Apperly, Irving and Reynolds in *A pictorial guide to identifying Australian architecture* (1989) describe characteristics of the Georgian style as "a pleasantly human scale, rectangular and prismatic shapes, symmetrical facades, and well-trieed proportions". The photo below of Breen's Inn at Berrima was used to illustrate characteristics of the style.

Style Indicators / *Victorian Georgian*

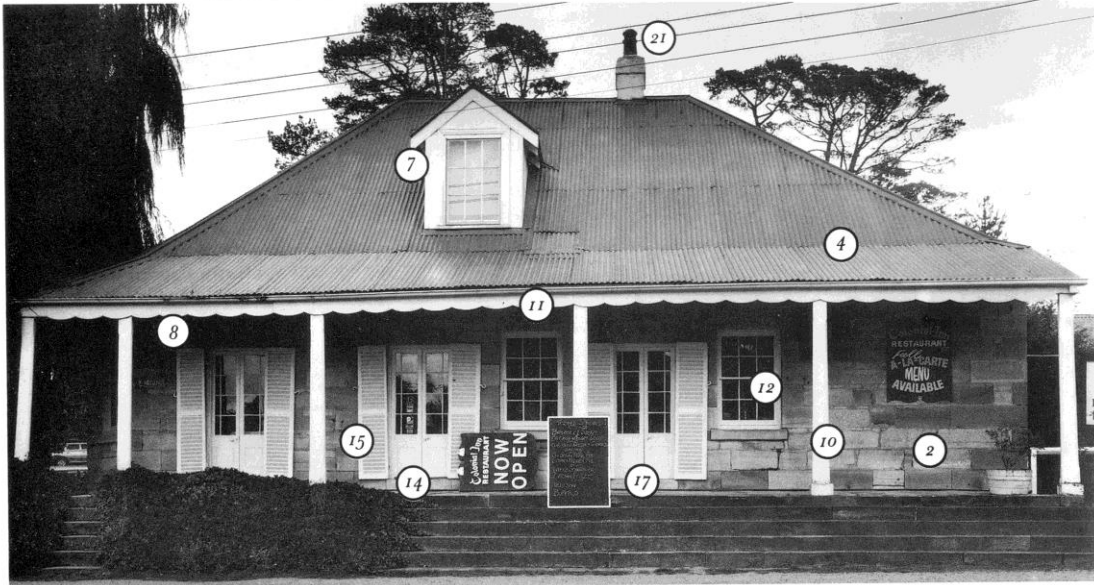

*Colonial Inn restaurant
(former Breen's Inn), Berrima,
NSW. Architect unknown, 1840s.
An informal composition of neat
Georgian details.*

Legend

- 2 Sandstone walling
- 4 Broken back galvanised iron roof
- 7 Dormer
- 8 Verandah
- 10 Slender verandah post
- 11 Decorative valance or verandah beam (Note: beam ornamentation should not be reproduced in new buildings)
- 12 Timber double hung sash window with small panes
- 14 Casement or French window
- 15 Louvred shutter
- 17 Timber panelled door
- 21 Brick chimney

Note: Non-symmetrical design is non- typical.

Elements of the Georgian style seen at Breen’s Inn, Berrima

Source: Apperley et al. 1989. P 44.

The architect, Ian Stapleton, has described the mid-nineteenth century cottage as “simple in style, like the house that a child draws, with a plain rectangular façade, a central front door and shuttered windows to either side, a hipped roof and veranda like a sun visor”. The drawings of early houses below (by Maisy Stapleton, reproduced from “Australian house styles”, 1997) show elements of the Georgian style that became traditional in Australia. New building work should have regard to these elements.

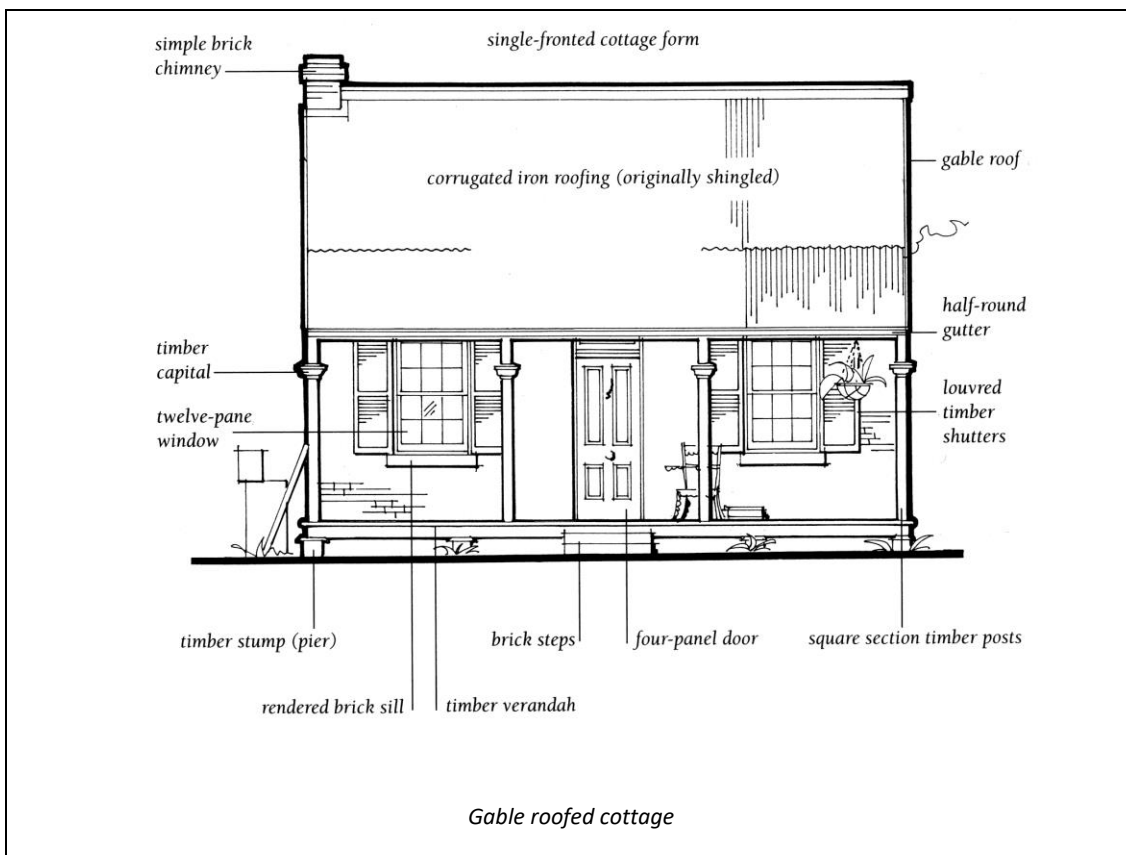

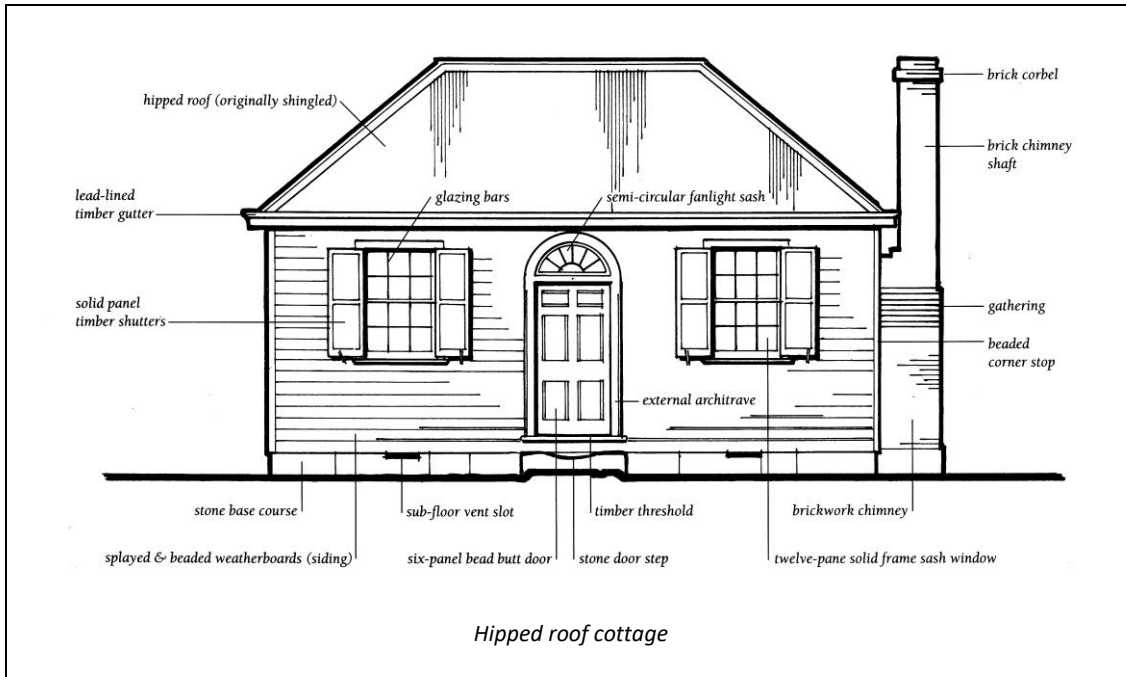

Elements of the Georgian style in gable roofed and hipped roof cottages

Source: Stapleton and Stapleton. 1997.

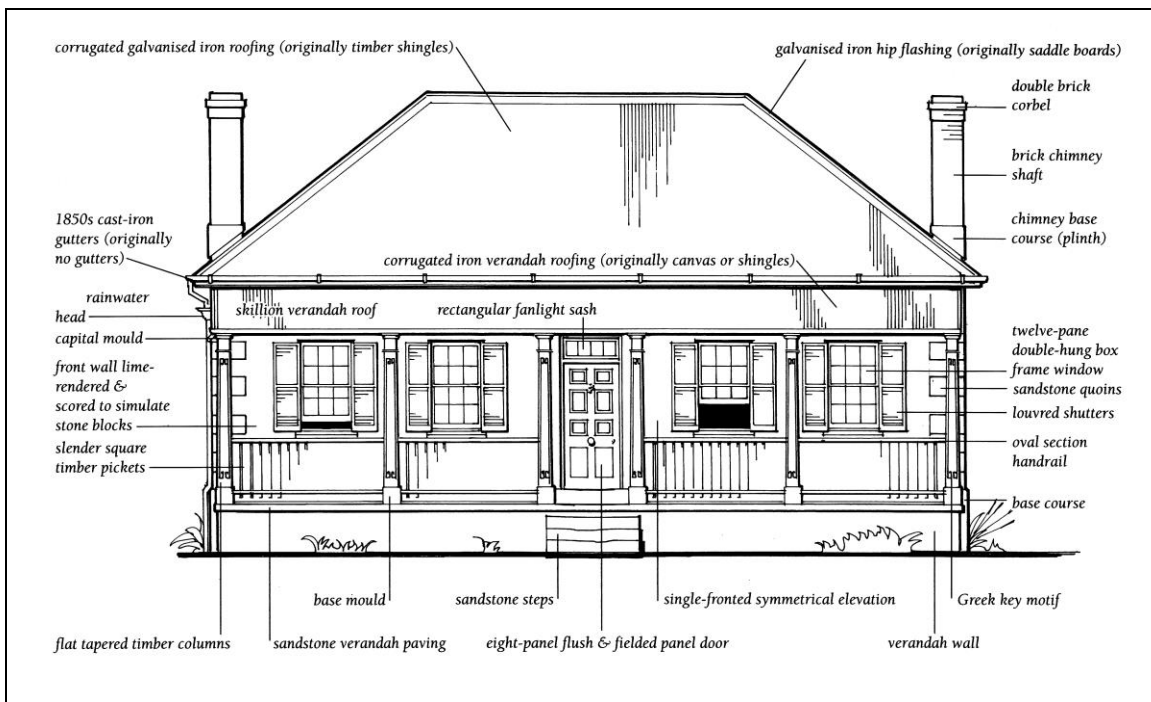

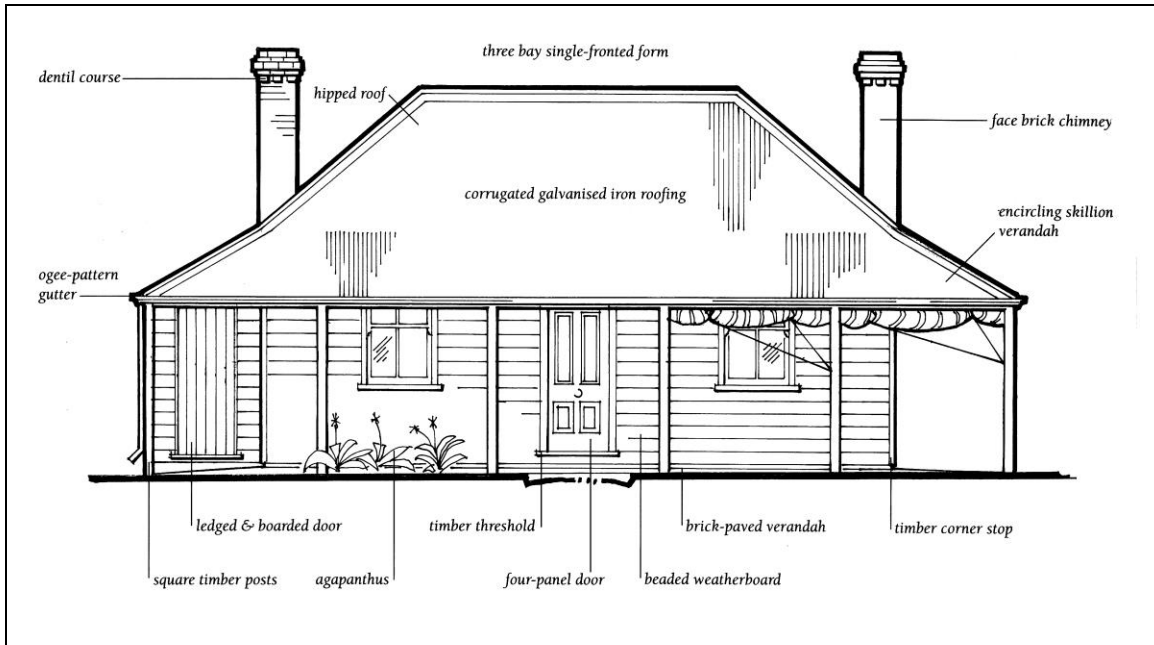

Elements of the Georgian style used in Australian cottages

Source: Stapleton and Stapleton. 1997.

A8.6.4 Controls

The controls applicable to all land within the Berrima Landscape Conservation Area are:

- (a) No building is to be erected that, in the opinion of Council, will be visually prominent when viewed from the village of Berrima, its approaches or any listed heritage item.
- (b) No development is to take place on the ridgelines that, in the opinion of Council, will be visually prominent when viewed from the Berrima Conservation Area, its approaches or any listed heritage item.
- (c) No development is to take place on the ridgelines that will, in the opinion of Council, have a detrimental impact on the rural bushland setting of Berrima or of any listed heritage item.
- (d) All new buildings and alterations to existing buildings shall be in the Georgian architectural style.

In addition to the above controls, further site specific controls apply for any Development Application lodged with Council for the following land:

(e) 4-6 Odessa Street Berrima

- (i) The site amalgamation and building envelope map at Figure 8.1 below is to be used as the basis for addressing any Development Application for subdivision of the subject land in accordance with relevant provisions of Schedule 1 (Item 33) of WLEP 2010.
- (ii) A Vegetation Management Plan must accompany any Application for development of the subject land in accordance with the relevant provisions of Schedule 1 (Item 33) of WLEP 2010.
- (iii) A Heritage Impact Statement is to accompany any Application for development of any lot resulting from the subdivision of the subject land, in accordance with the relevant provisions of Schedule 1 (Item 33) of WLEP 2010.



Figure 8.1 Odessa Street Lot Plan

(f) Land at Nathan Street Berrima

- (i) The site amalgamation and building envelope map at Figure below is to be used as the basis for addressing any Development Application for subdivision of the subject land in accordance with relevant provisions of Schedule 1 (Item 34) of WLEP 2010.

- (ii) A Vegetation Management Plan must accompany any Application for development of Lot 64 DP 7511252 in accordance with the relevant provisions of Schedule 1 (Item 34) of WLEP 2010.
- (iii) A Heritage Impact Statement is to accompany any Application for development of any lot resulting from the subdivision of the subject land, in accordance with the relevant provisions of Schedule 1 (Item 34) of WLEP 2010.

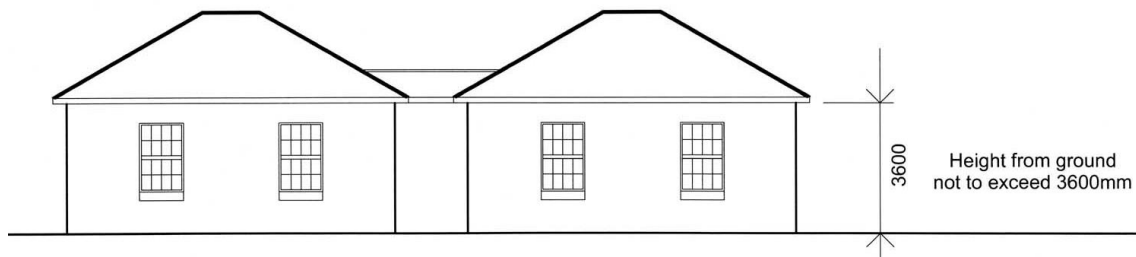

Figure 8.2 Nathan Street Lot Plan

Unity of Built Form

- (a) Two-storey development is not permitted. Single storey development predominates in the vicinity, sometimes with an attic incorporated within the roof line. No building shall exceed one storey plus pitched roof with dormer windows (often referred to as one and a half storeys).
- (b) The level (RL) of the ridgeline or highest roof point of any development shall not exceed the level of the ridgeline or highest roof point of the original building (or in the case of a new development the nearest heritage listed dwelling).

- (c) The height from natural ground to the eaves of any new building shall not exceed one (1) storey.
- (d) Additions shall have a finished floor level not in excess of 600mm above natural ground level.
- (e) The roof form, roof pitch, wall and roof materials, eaves overhang and height-to-width ratio of windows within any new construction visible from the street or adjacent public domain shall complement the architectural character of the original dwellings in the conservation area.
- (f) The form of any roof projection or opening, where permitted, shall complement the original roof form and architectural character of the original dwelling or nearest original dwelling.



Height of buildings is not to exceed 3600mm from natural ground to eaves

- (g) Buildings may include attics provided they are contained within the roofline and do not have the appearance of a second storey from the exterior.
- (h) Alterations and additions should be sited to retain the visual characteristics of the original development when viewed from the street of adjacent public domain i.e. single detached building.
- (i) Buildings may include below ground basements provided they are not apparent from the exterior.
- (j) Buildings should follow natural ground levels and should step to follow natural topography, without above ground platforms or banks. As a concession for sloping sites, a maximum cut of one metre may be considered.

Form and Scale

- (a) External alterations and additions shall only be permitted to the front of a building where:



- (i) the alterations or additions will reinstate the original façade and details thereof, and/or,
 - (ii) the alteration is to a previous unsympathetic addition and will enhance the streetscape character.
- (b) The enclosure of original unenclosed front porches or verandahs shall not be permitted.
- (c) The original roof shall not be replaced with an alternate form.
- (d) For blocks with two street frontages or a front boundary adjoining a public reserve or pedestrian way, additions to one side elevation may occur with a reduced setback provided the apparent form of the original building is retained.
- (e) Additions to buildings should be designed to minimise disturbance to the form of the building. Wall articulation and roof form should complement the building. Roof forms larger than the original roof should not be added. Wherever appropriate, additions should be built as separate structures (pavilions) compatible in form with the existing, connected by a covered way. Separation between the original building and addition should be sufficient to clearly visually discern the original from the addition and provide minimal disturbance of original fabric. The building scale of extensions should appear to be of lesser scale than the original, with a lower ridge height than existing, unless adopting the pavilion model.
- (f) The restoration of any enclosed porches and verandahs to their original open design should be encouraged.
- (g) The restoration of non-original roofs to their original form should be encouraged.



Successful additions retain the original cottage roof form

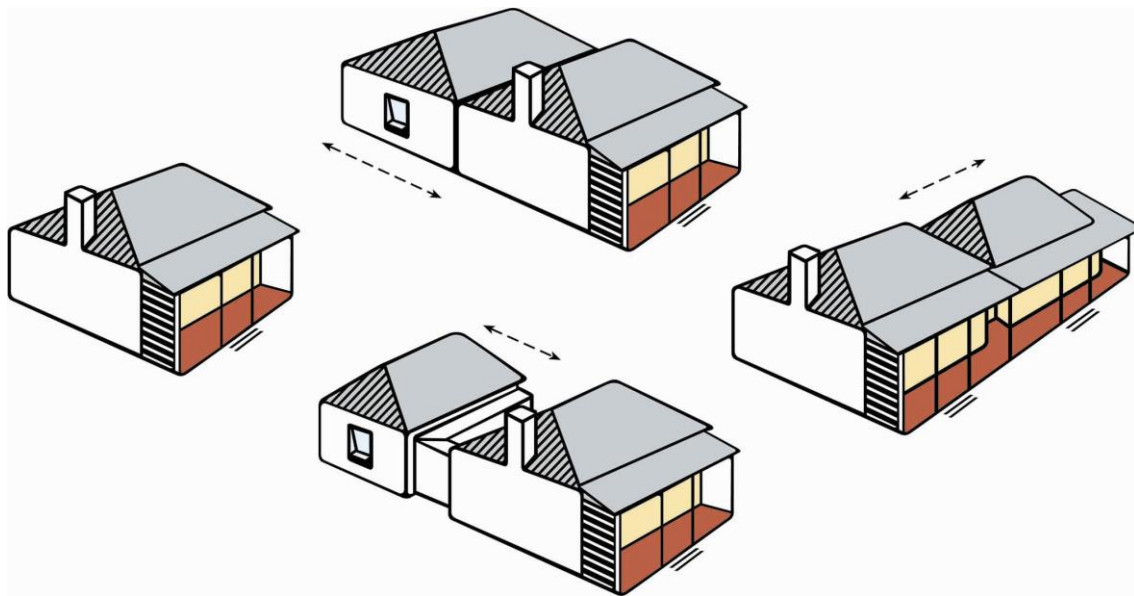

Additions should minimise disturbance to the roof form of the building.

Setbacks

- (a) Side setbacks for new buildings shall be not less than 1.5 metres.

Architectural Treatments

- (a) Alterations and additions that will be visible from the street or adjacent public domain should match the original details, materials and finishes for key elements including roofing and ridge capping; gutters and downpipes; fascias and eaves; wall finishes and decorative treatments; windows including fenestration patterns; entrance doors; and verandah joinery. Details, materials and finishes at locations not visible to the adjacent public domain should complement the original.
- (b) All buildings are to reproduce Georgian dwelling proportions externally. The basic single storey dwelling was two or four rooms with a central hall, with symmetrically placed timber windows, topped by a hipped roof at a pitch of approximately 30 degrees. Windows were not usually built at the ends of the house and a verandah was sometimes later added. An upper level, if one existed, was an attic space housed within the roofline, except for dormer window projections.





Georgian building proportion examples



Wall Cladding

- (a) External wall cladding materials shall only be stone (stone colour, mortar and coursing to be similar to original), or timber weatherboard, or rendered masonry (painted in flat paint finishes or integrally coloured renders in earthy tones), pise, corrugated galvanised metal or timber slabs of traditional appearance. No other wall cladding materials shall be permitted. Chimneys may be face brick. Imitation timber weatherboards ("reconstituted" wood weatherboards, fibrous cement weatherboards and the like) to external walls of buildings shall not be permitted.

Roofs

- (a) Roof cladding shall be corrugated profile steel in galvanised finish or timber shingles. No other roof cladding materials shall be permitted. Gutters and downpipes shall be galvanised finish. Gutters may be traditional half-round, ogee or quad profiles. Downpipes shall be round profile.
- (b) Roof elements such as skylights, solar hot water heaters, air-conditioners and telecommunications masts or dishes shall be sited to minimise visibility from the street or adjacent public domain. In the case of heritage buildings, these roof elements shall not be visible from the street or adjacent public domain.
- (c) Roofs to reproduce Georgian period detailing. Roofs to be pitched 30 to 40 degrees. The use of recycled corrugated iron with traditional screws is encouraged. Hip, ridge and barge board caps to be roll-cap. Hipped roofs predominated over gabled roofs.

Chimneys

- (a) Chimneys visible from the street or adjacent public domain should be retained. New chimneys visible from the street or public domain should match the original proportions, finishes and capping detail. Chimneys were built of un-rendered brick or stone and were characterised by a 150mm corbel at the top of the chimney, with an arched cowl or chimney pot.



Chimney examples

Windows

- (a) Windows to reproduce Georgian period detailing. Windows were vertically proportioned. A typical window was 12-paned timber double-hung, with each pane measuring 8 x 10 or 10 x 12 inches. Each window had a double sash with 6 panes in each sash. Window heads were flat arched.





Window examples

Doors

- (a) Doors to reproduce Georgian period detailing. Doors were made of solid timber and were centrally placed in the front of the building. Typically, they were 7 feet high, 3-4 feet wide, and generally 2 inches thick. The principal entrance door had either six or four solid panels. Some panelled doors were infilled (except for a bead pattern) prior to the 1860s. Secondary doors (say to outbuildings) were usually vertical boarded. French doors often each had two vertical glazed above a solid bottom panel. Bottom panels were solid timber with expressed stiles in a square or “gunstock” pattern.



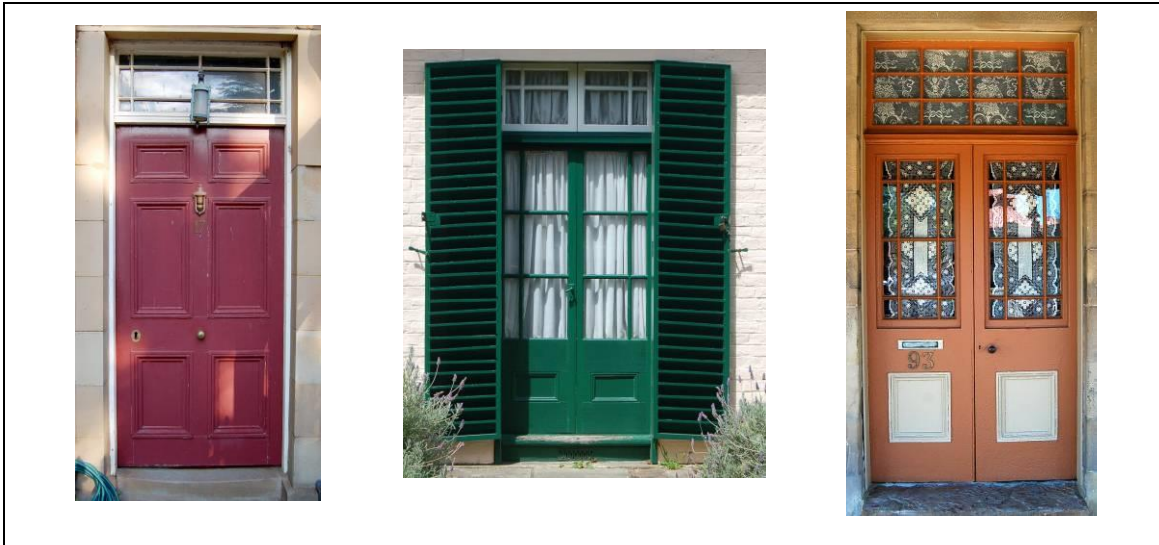

Door examples and details

Shutters

- (a) Shutters to reproduce Georgian period detailing, be of timber construction and operable. A typical shutter was a minimum of 45 mm thick and detailed to match traditional construction of the period.

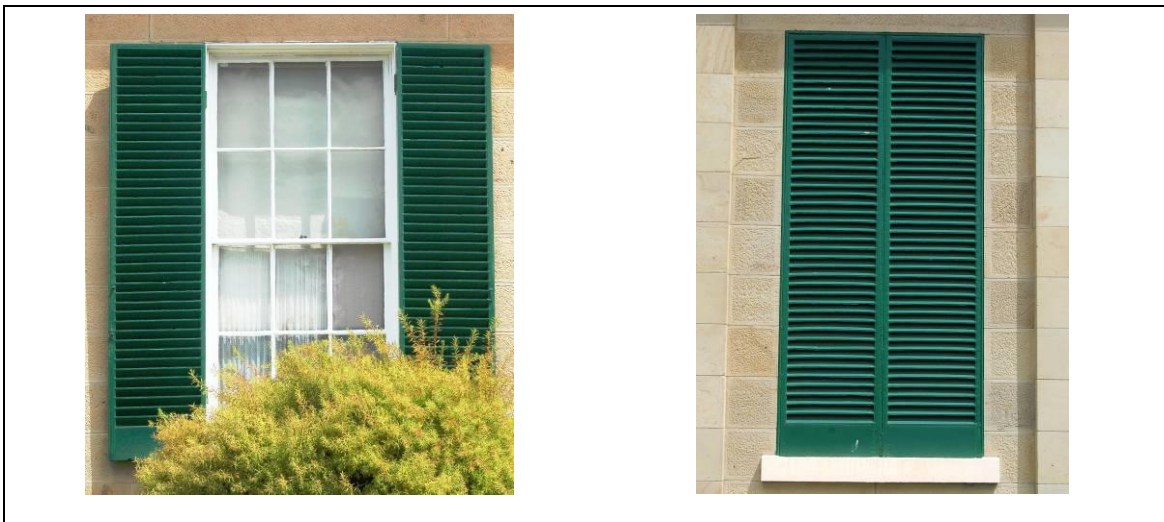



Shutter examples

Dormer Windows

- (a) Dormers to reproduce Georgian period detailing. The front of a dormer window was a 12-pane sash window no larger than other windows in the

building, with flat pilasters on either side of the window frame to support the gable or pediment. Some dormers had scalloped barge boards. Not many dormers were used and in-plane skylights to attics are preferable to dormers in most instances.



Dormer window examples

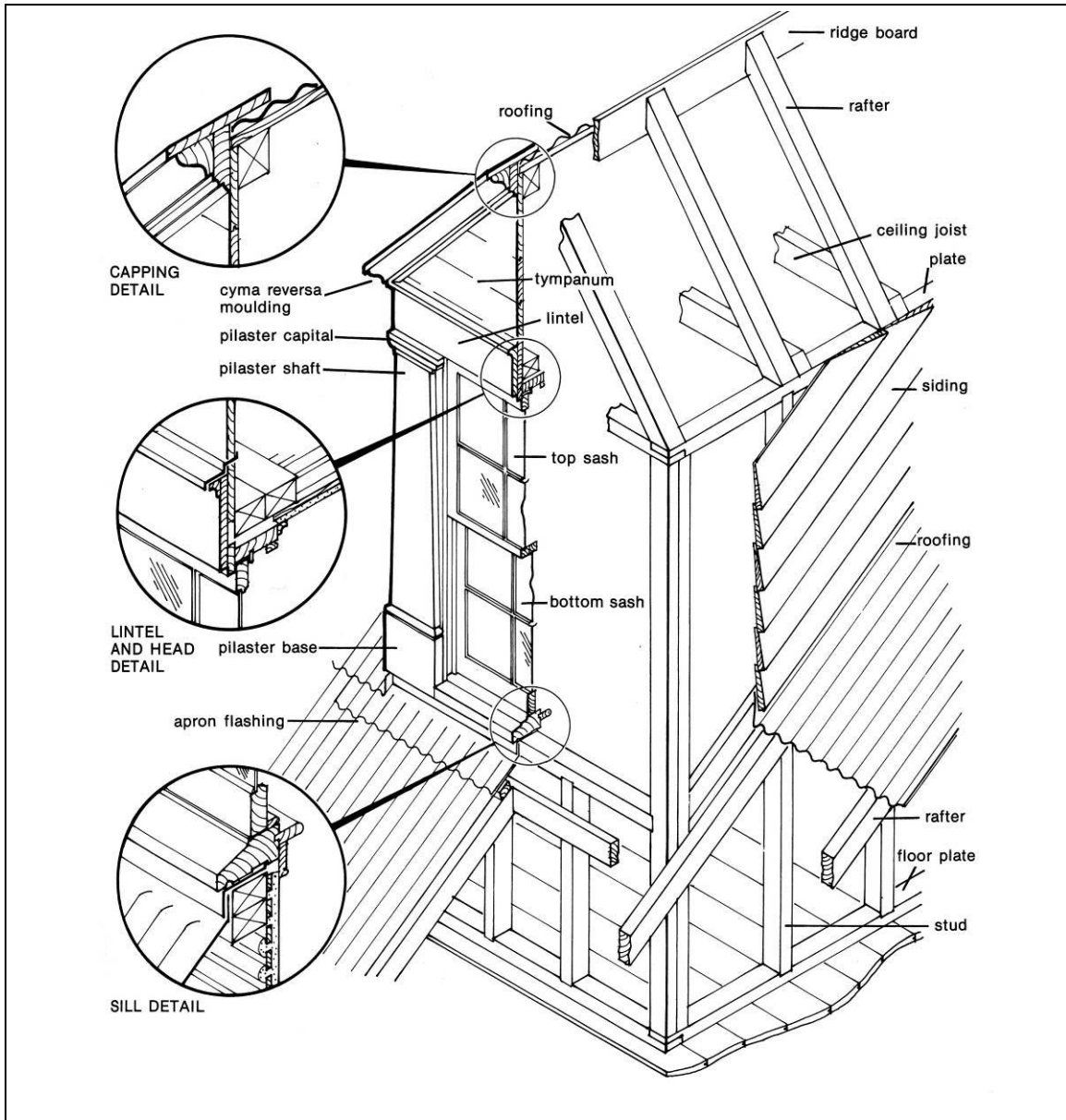

Construction of a typical Georgian style dormer window

(Source: Ian Stapleton, "How to restore the old Aussie house", 1983)

Verandas

- (a) Verandas to reproduce Georgian period detailing. Skillion or hip roofed verandas were common. Bull-nose verandas tended to appear a century later and are not encouraged. Verandas were most commonly supported by

4 posts, or any even number of posts, although some verandas had five posts. Posts were either timber or cast iron. Round columns are not encouraged. Sides of verandas were usually closed in to the line of the roof. Decorative veranda brackets, valances, and lacework became more common only after 1870 and are not encouraged.





Veranda examples

Fences

- (a) Except hedges, all fencing in front of the main elevation of the house must be able to be seen through (i.e. not a solid wall). Fence types shall only be one of the following and consistent with the style of building being fenced: woven wire with steel posts and rails in timber sizes, wire with timber strainer posts, mesh with timber strainer posts, timber post and rail, timber picket or timber paling.
- (b) All front fences and boundary fences to the road shall be constructed to a maximum height of 1200 mm above natural ground level.
- (c) All existing and future front boundary hedges shall be maintained at a maximum height of 1200 mm above natural ground level.
- (d) Fencing along boundaries to public open spaces, where installed, shall be either of wire or wire mesh utilising timber straining posts or of timber post

and rail design to a maximum height of 1400 mm. Hedges, trees and shrubs may be planted for privacy.

- (e) Internal boundary fences including those between lots, where installed, shall match the fencing along boundaries to public open spaces OR be stone or timber paling construction to a maximum height of 1600 mm not extending forward of the building line. Neighbours may plant hedges, trees or shrubs in addition to or instead of fencing.
- (f) Hollow section metal picket and metal sheet fencing shall not be permitted.
- (g) Pedestrian gates or driveway pillars forward of the building line should only be permitted where they are integrated with hedge planting and are less than 1200mm in height above natural ground level.
- (h) Reconstruction of known original fences using traditional technology and materials is encouraged. The style, detail and materials of fences should be consistent with the period of the building.
- (i) The colour of fencing should be selected from the palette of acceptable colours as indicated below. White coloured fencing is generally not acceptable, particularly outside the residential zoned area.
- (j) Wire should be galvanised finish or painted in a dark or black colour.





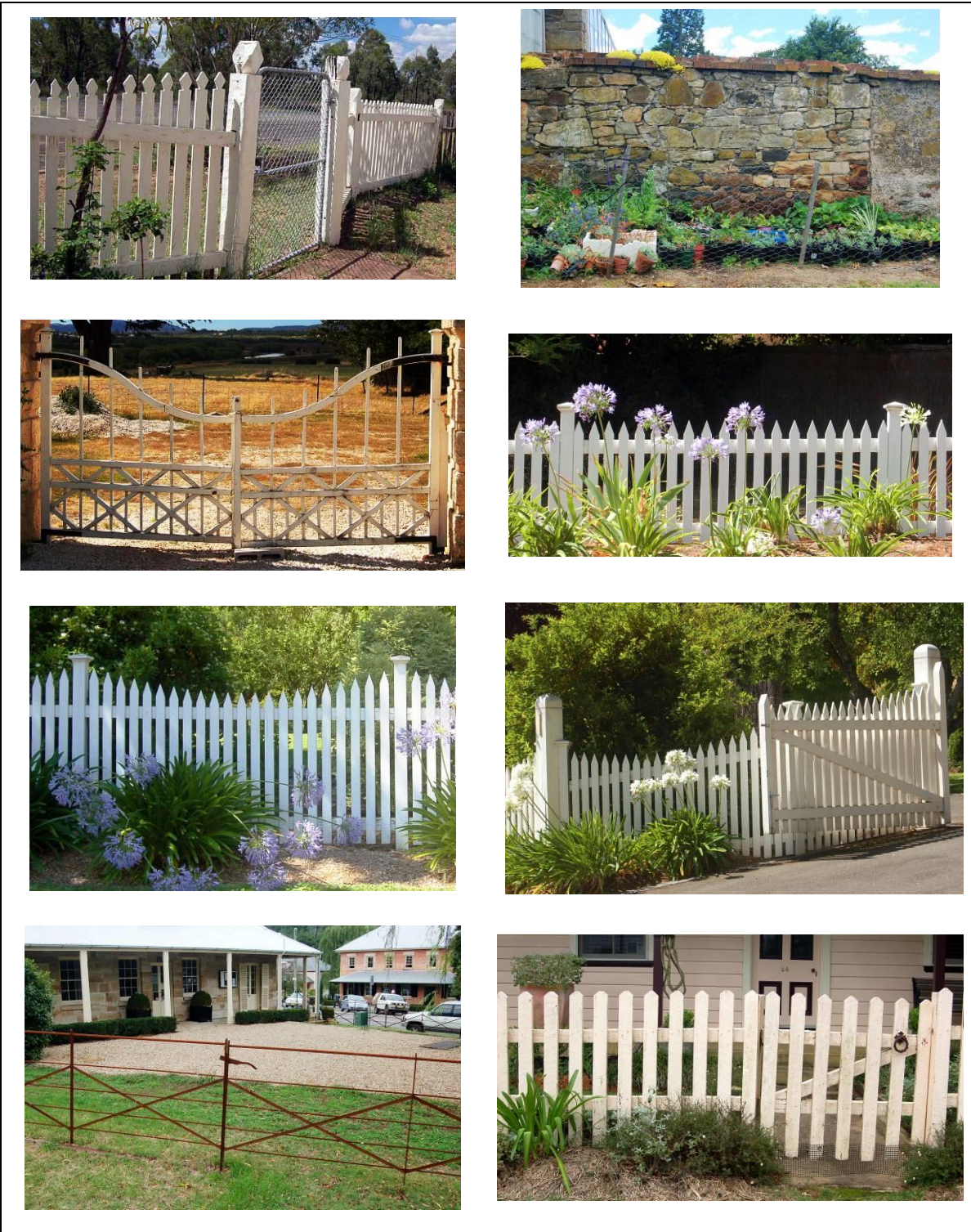

Fence and gate type examples

Outbuildings

- (a) Outbuildings shall be detached from the dwelling.
- (b) Outbuildings shall be located to the rear of the property, behind the rear wall of the dwelling.
- (c) The outbuilding should be smaller than the main building.
- (d) Outbuildings should reproduce Georgian period detailing, as illustrated below.







Traditional outbuilding examples

Colour Palette

- (a) Colours for all development shall match or closely resemble the palette of colours indicated over.
- (b) A detailed exterior colour scheme must be presented to allow Council to assess the proposed colours against the existing streetscape.

Notes: Creams to be used for walls. Dark colours for timber joinery only. Close equivalents from other manufacturer's colour ranges may be considered. French Grey was an interior colour only.



Palette of acceptable colours

(Source: Pascal Heritage Colour Chart c.1980)



A8.7 Burradoo Landscape Conservation Area

A8.7.1 Description

The Burradoo Landscape Conservation Area encompasses the green space on either side of Moss Vale Road between Bowral/Burradoo and Moss Vale. It includes the Bong Bong Common which was the site of the Government settlement of the village of Bong Bong of which only archaeological evidence remains. The Burradoo Landscape Conservation Area is characterised by its open rural character which has been compromised in some areas by large screen and windbreak planting. Its importance lies in the fact that it provides a separation between the settlement areas of Bowral/Burradoo and Moss Vale.

A8.7.2 Objectives

The objectives for the Burradoo Landscape Conservation Area are to:

- (a) Maintain the separation between the settlement areas of Bowral/Burradoo and Moss Vale.
- (b) Maintain the open rural setting of the area.
- (c) Ensure that development remains sparse.
- (d) Retain the significance of Bong Bong Common.

A8.7.3 Controls

The specific controls for the Burradoo Landscape Conservation Area are:

- (a) A landscape plan is required for all plantings that are expected to reach a mature height of greater than 1000mm.
- (b) Development on Bong Bong Common to be in accordance with the Bong Bong Common Conservation Management Plan.

A8.8 Joadja Conservation Area

A8.8.1 Description

Joadja contains the remains of plant and an associated settlement that developed around the refining and processing of oil into kerosene and secondary products such as waxes and candles by a company called the Australian Kerosene Oil and Mineral Company. Joadja is uniquely well-preserved because the site was abandoned after only 25 years of operation. The totality of the site is an extremely unusual record of



every aspect of life in an industry which was important for Australia in the 19th century. The site has considerable archaeological potential and has social significance because the skilled workers, who also lived on the site, came with their families from Scotland. The village had good community facilities: a community hall used for church meetings (both Presbyterian and Catholic), a school, a school of Arts, a chemist and (later) a hotel. The village of Joadja is thus an early instance of a company town characterised to an unusual degree by company control of immigration.

A8.8.2 Objective

The objective for the Joadja Conservation Area is to only permit development that will ensure the retention of the historic layout and remaining structures.

A8.8.3 Controls

There are no specific controls for the Joadja Conservation Area.

A8.9 Throsby Park Conservation Area

A8.9.1 Description

The Throsby Park site is linked with the earliest occupation of the area from circa 1819 and associated with well known figures in history, such as Dr Charles Throsby and his nephew Charles Throsby. The conservation area includes the Throsby Park homestead, cottage, stables, gardens, Mill and outbuildings, The Barn, and Gundagai Cottage.

The statement of significance for the Throsby Park Group is as follows:

The Throsby Park group is significant in the evolution and pattern of history in NSW. This area is a cultural landscape which contains a cluster of cultural features which illustrate the human occupation and evolution of the locality of Bong Bong and the early European settlement of NSW. The group is rare in that it contains evidence of the development of agriculture from pastoral beginnings and subsequent diversification in a setting which remains rural although modern subdivision is encroaching on views from the Site. The property is also historically significant for its associations with the Throsby family spanning five generations, and in particular, with Dr Charles Throsby, a figure of importance in the exploration and development of the colony of NSW.

A8.9.2 Objectives

The objectives for the Throsby Park Conservation Area are to:

- (a) Protect the view from Throsby Park cottage and homestead to the north.



- (b) Protect the view down to the Illawarra Highway, to the west and south from Throsby Park homestead.
- (c) Protect existing trees.

A8.9.3 Controls

The specific controls for the Throsby Park Conservation Area are:

- (a) New buildings along the Illawarra Highway and Throsby Park Road are not to be visible from the road.
- (b) Existing trees and gardens are to be retained.
- (c) All areas in the Throsby Park Conservation Area are to be considered archaeological areas and new development must be undertaken in accordance with the NSW Department of Planning and Heritage Council Historical Archaeology Code of Practice.



Section 9 Construction Standards & Procedures

A9.1 Introduction

When preparing detailed plans, applicants are directed to the following surveys and reports which may be required to address specific site conditions and to Council's construction standards with regard to certain matters. Council inspection procedures with regard to certain matters are also addressed in this Section.

A9.2 Surveys and Reports

Council may require the preparation and submission of certain reports when a new Land Use Application is lodged. These are detailed below.

A9.2.1 Geotechnically Sensitive Areas

A geotechnical report, prepared by a suitably qualified consultant, is to be lodged with the development application. The report should generally address the publication *Landslide Risk Management Guidelines (2007)* produced by the Australian Geomechanics Society. Appropriate professional indemnity insurance must be held by consultant.

A9.2.2 Structural Stability

Where there is a Geotechnical Report that relates to the Allotment, any Engineer's design shall carry the following statement:

"A geotechnical risk assessment report no....prepared by....and dated....has been examined by myself and I have given due regards to its recommendations and hereby certify that the design has been prepared to ensure the longevity of the building."

All designs shall nominate a site classification vide AS 2870 *"Residential Slabs & Footings Code"*.

A9.2.3 Hydraulic Details

Hydraulic details, prepared by a suitably qualified hydraulic consultant, shall be provided for:

- a) Stormwater service
- b) Water supply service (including fire services)
- c) Sewerage service
- d) Trade Waste discharges to sewer for all buildings except a single dwelling house and associated outbuilding(s). These details are to be submitted with a development application if deemed necessary or with the Section 68 application to Council.



A9.2.4 Site Survey Reports

During construction, Council may require the submission of a survey report prior to the pouring of concrete and then upon completion of the building works (prior to occupation), in the following circumstances:-

- a) Where a Class 1-9 building is located within 300mm of the minimum side boundary setbacks, (including distance to wall and distance to eaves/gutter)
- b) Where a structure is located within 300mm of a registered easement
- c) At floor level stage, prior to the pouring of concrete or fixing flooring material, where the property is within an area affected by flooding inundation.

A9.3 Building near or over Council Mains and Easements

NB: Structures are to be erected clear of Council's water, sewer and drainage mains by a minimum of one (1) metre and 1.2 metres for a sewer manhole and shall be clear of any easement over such a main. The following controls apply only in those situations where Council is satisfied that there is no alternative to the proposed location.

A9.3.1 Sewer Mains

Under no circumstances will Council permit a building to be erected over a sewer rising main.

Council may permit the building over a sewer main in accordance with the following:

- a) The maximum length of the sewer main built over by an unelevated structure (ie. Less than 1.7 metres clearance above the pipe) shall not exceed 12 metres unless otherwise authorised by Council.
- b) A registered easement over the main being granted at the owner's expense.
- c) Where replacement, augmentation or amplification of the sewer main is required, the pipes shall be UPVC or cast iron at a cost to be negotiated between the owner and the Council.
- d) No building is permitted over a sewer manhole.
- e) The unobstructed personal access of minimum width 900mm shall be provided to any manhole located upon private property.
- f) A building shall not be erected within the area of influence above the angle of repose of 45 degrees for normal loam/clay/sand foundations, or 60



degrees for rock foundations measured 600mm from the outside of the pipe for the trench bottom.

- g) Piers designed by a professional engineer shall be provided to carry structural loadings below the invert level of the main. In all circumstances the clearances between a building and a main or drain shall be to the satisfaction of special requirements of the Council.

A9.3.2 Construction Requirements

The weight of any building shall be distributed away from any sewer main or stormwater drain by pier & beam construction. The piers shall be embedded on firm foundation at least 300mm below the invert of the pipe with a minimum horizontal clearance from the pipe of 600mm.

A9.3.3 Water mains

No building is permitted over a water main.

A9.3.4 Other mains

No building is permitted over a stormwater drain or easement unless special extenuating circumstances prevail, and permission is resolved by the Council.

A9.3.5 Proximity to easements

A structure is permitted to be constructed up to a registered easement (but not encroaching on the easement unless permitted in the wording of the easement). If a structure is to be located within 200mm of a registered easement, Council will require the submission of a survey report at footing stage and prior to occupation of the building.

A9.4 Building over two or more Allotments

- a) If building work is proposed over two or more allotments, Council may require the consolidation of these lots.
- b) If the minimum allotment size required to allow development consent to be issued within the zoning or the area necessary to allow adequate septic effluent disposal requires more than one lot, Council will require the consolidation of the lots. This shall occur prior to issue of a construction certificate.

A9.5 Subfloor Areas of Buildings

Subfloor enclosures, using a material compatible with the subject structure, shall be provided. Where visible from the public road, (note: the provision of landscaping does not affect the



visibility from the road) subfloor enclosure is to be provided along the road frontage with a return to the first pier on the side elevations.

A9.6 Exhaust Fans

Any exhaust fan provided in the kitchen ceilings and walls shall be ducted directly outside to prevent the build up of condensation, fats and the like.

A9.7 Water Storage in Non-reticulated Areas

A minimum of 40,000 litres Water Storage capacity must be provided for domestic purposes unless supplemented by supplies from an approved bore.

A9.8 Stormwater Disposal

Final means of disposal of stormwater to Council's stormwater system must be approved by Council. The following types of disposal will generally be acceptable:

- a) **Disposal to an interallotment drainage system with connection to the junction provided** - Where no junction is provided, a new 45° sweep is to be laid in the interallotment drain for connection. Any other form of connection is prohibited.
- b) **Disposal to Council's kerb and gutter by connection into the outlet provided** - Where no outlet is provided in the kerb and gutter a saw cut of the kerb and gutter will be permitted and pre fabricated galvanized steel stormwater adapter approved by Council is to be placed within the kerb. A high strength concrete mix shall be used to reinstate the kerb and this must match the profile of the kerb. Where more than one outlet is to be placed within a kerb a spacing of two (2) metres between the outlets shall occur.
- c) **Disposal to Council's road table drain** may occur provided the pipe is maintained a suitable distance from the road carriageway to ensure damage does not occur. The outlet of the pipe must be protected by the placement of solid protection, such as concrete around the outlet to prevent damage to the pipe. Other means of disposal to the table drain in areas without kerb and gutter may be accepted by Council. Details are to be submitted and approved.
- d) **Disposal directly to Council's stormwater mains** is permitted subject to certain conditions. Details are to be obtained from Council's Engineering staff.
- e) **On site stormwater disposal** may be permitted. On allotments with an area of less than 4000m² a hydraulic consultants report may be requested by Council to verify that on site disposal can occur without damaging buildings, cause a nuisance to neighbouring properties or create a problem through adding



stormwater into the ground surface (A Geotechnical Engineer may also be required to verify this issue).

- f) The disposal trenches shall be located a minimum distance of 5 metres from any adjoining property boundary. In circumstances where there is a larger roof and hardstand area, or soil conditions make disposal unsuitable, other means of disposal will be required. Stormwater/retention trenches must be located downstream of any septic tank effluent/sullage disposal area. Trenches, drains and pipes shall not traverse or penetrate any effluent disposal area. The typical size of trench for each downpipe is 3 metres long, 600mm wide and 600mm deep however this is dependant on soil conditions. Where concealed gutters, box gutters, high fascia gutters (without stormports) and/or internal downpipes have been installed it is advisable that a surcharge grating mounted above the finished surface be installed adjacent to the base of the downpipe connection of the drain/pipe.
- g) Where adverse falls occur from the roof drainage system to the final disposal point, the proposed method of drainage and disposal is to be submitted to the Council for approval. In these instances the provision of an easement with the fall of the land to Council's stormwater disposal system, is the most suitable solution. For on site disposal options see above. *A pump system for conveyance of stormwater will not be permitted.*
- h) **Disposal of stormwater into collection tanks** will be permitted by Council provided the over flow is conveyed to a means of disposal specified in 1-6 above as appropriate. Where the water is to be used for domestic purposes, a first flush system should be installed and must be compliant with all BASIX conditions.
- i) Stormwater runoff from areas where water may become polluted will be subject to suitable pre-treatment measures as specified by Council and other statutory authorities.

A9.9 Structures Over Public Areas

A9.9.1 Verandah Awnings

Refer also to BCA prescribed standards.

NB: Requirements for Seismic loadings.

- a) Spacing of posts shall be a minimum of 3 metres.
- b) The posts shall have a minimum size of 100mm x 100mm.
- c) Only square section timber or metal posts shall be used.



- d) The awning shall be 600mm from the kerb to the gutter edge.
- e) The colour and design shall comply with any Council specified village colour scheme and design.
- f) The posts shall not be erected within the zone of influence of any services.
- g) The underside of the awning shall have a minimum clearance of 3 metres above the footpath. The Council may require that any or all awning or verandahs proposed to be erected over a road be of the cantilever type.
- h) The width of a cantilever awning that extends beyond a road alignment must not exceed 3660mm and must be a minimum of 600mm back from the roadside edge of the kerb.

A9.9.2 Pipes and services

- a) Pipes and services must not project beyond the road alignment, except as provided by this clause.
- b) Rainwater heads may project not more than 450mm and rainwater downpipes may project not more than 150mm above a height of 2700mm above the pathway level.
- c) In the case of an existing building, the Council may approve the projection of essential service pipes.
- d) Construction of projections - Projections beyond the road alignment are to be constructed so that they may be removed at any time after their erection without causing the building to which they are part to be structurally unsafe and without causing a reduction in the required fire-resistance rating of any structural member of the building. Projections shall also fully comply with seismic loading requirements.

A9.10 Site Access Standards During Construction

- a) All Council assets (eg sewer manholes, stormwater systems etc.) shall be protected from damage. An inspection of the existing assets shall be carried out prior to the commencement of any work on site. Vehicular access to the site shall be via a single designated access point. This point is to be located so that the possibility of damage to Council's property is minimised during construction and shall be constructed to Council's satisfaction.
- b) The building supervisor is responsible to ensure that all contractors, sub-contractors and delivery trucks use the designated access point. Repairs to damaged grass verges, drainage lines, concrete footpaths, kerb and gutter are to



be carried out by the builder/owner/contractor to Council's specification and supervision prior to occupation of the development.

- c) The kerb, gutter and footpath adjoining the site must be kept clear of soil and debris during the course of the construction.
- d) If there is no kerb and gutter, the designated access point shall be provided with adequate provision to prevent the damage of any underlying services or drains, or damage to the surface of any swale drain.

A9.11 Footpath Protection During Construction and Hoardings

- a) Hoardings – Approval from Council required prior to erection along with payment of appropriate fees.
- b) For building construction work in commercial and industrial zones the building standard for protection of public foot paths and roads shall be:-

Type A – Fence Type Hoarding Requirements of Division of Inspection Services, Workcover Authority.

Type B – Overhead type Hoarding Requirements of Division of Inspection Services, Workcover Authority. Hoarding standard for multi-storey construction within 3.5 metres of a public footpath or road, that exceeds a height of 7.5 metres from any point on that frontage.

A9.12 Waste Management and Disposal

A9.12.1 Introduction

This section of the DCP provides Council's general requirements for waste minimisation, management and recycling for development throughout the Shire. These requirements include waste management objectives and development controls derived from the NSW Department of Environment and Climate Change's Publication titled Model Waste Not DCP Chapter (dated July 2008).

A9.12.2 Objectives

- a) To minimise the volume of waste generated during demolition and construction phases of development.
- b) To promote demolition and construction techniques which maximise recycling and reuse opportunities of waste materials.



- c) To minimise the volume and type of waste going to landfill.
- d) To avoid illegal dumping of waste across Wingecarribee Shire.

A9.12.3 Controls

Prior to all demolition and / or some construction works

- a) A Waste Management Plan is required for all demolition works and /or construction works (with a value greater than \$50,000).
- b) Consideration must be given to re-using existing materials, or parts thereof, on the subject site for the proposed use.
- c) Applicants must demonstrate a commitment to waste minimisation by completing a Waste Management Plan that will minimise material going to landfill.
- d) The Waste Management Plan must address the following requirements (as a minimum):
 - i. Volume and type of waste, land fill and recyclables to be generated.
 - ii. Storage and treatment of waste and recyclables onsite.
 - iii. Facilities proposed to receive residual waste and recyclables.
- e) Where the building contains asbestos, Council will ask for verification of the disposal technique used, the amount removed and the disposal location for the asbestos materials. This documentation will need to be submitted within 7 days of off site disposal.
- f) Receipts from the disposal of residual waste and recyclables are required to be retained by the applicant in order to confirm the lawful disposal of these materials.

A9.12.4 During Construction

- a) Construction activities are to be managed so that waste is sorted, reused or recycled, where possible. Potentially windblown rubbish such as foam, cardboard or plastic must be stored on the site within a receptacle with a tight fitting, secure lid.
- b) Any fill removed from the site shall only be placed on an approved waste disposal facility and as detailed in the Waste Management Plan.
- c) It is not acceptable to dispose of all waste material generated from construction to landfill. Instead, applicants must demonstrate a commitment to waste minimisation. The Waste Management Plan must demonstrate implementation of the following during construction (as a minimum):
 - a. Installation of waste storage receptacles, and



b. Sorting of waste into material types.

d) Receipts from the disposal of residual waste and recyclables are required to be retained by the applicant in order to confirm the lawful disposal of these materials.

A Waste Management Plan Template is available at Council or on Councils website as part of the land use application forms.

A9.13 Inspections under a Section 68 approval

For inspections relating to water, stormwater, sanitary drainage and effluent disposal systems under a Section 68 approval under the Local Government Act 1993, Council shall be notified twenty four (24) hours in advance that the following works are ready for inspection. A satisfactory inspection shall be carried out prior to covering any completed works.

- (a) Stormwater drains if acting as the PCA (NB Council inspects stormwater drainage within properties only where a Hydraulic Consultant has NOT completed a hydraulics design)
- (b) Stormwater absorption trenches
- (c) Internal sewer drains under water test
- (d) External sewer drains under water test
- (e) Water plumbing
- (f) Pump well and associated pump lines
- (g) Septic tank or aerated wastewater treatment system

Absorption trenches

- a) Final inspection of water plumbing, on site septic disposal, sanitary drainage and stormwater drainage
- b) Works in relation to road reserves, footpath, kerb and gutter, road shoulder and drainage within public lands or road reserves

A9.14 Civil Design & Certification

On completion of works and prior to occupation, certification from a Professional Engineer shall be submitted to Council detailing that all internal civil works are in accordance with the approved plans and specifications for developments where these plans were required by Council. The relevant Hydraulic Consultant shall certify that stormwater and any fire services installed are in accordance with the Council accepted design.



A9.15 Re-sited Buildings

- a) A development application for a re-sited building shall be accompanied by photographs of all elevations of the building.
- b) Council will carry out an inspection of all proposed re-sited buildings located within the Shire and may require inspection of buildings located outside of the Shire. If Council does not require an inspection of the building the following reports are required:
- c) a letter from a professional engineer regarding the structural stability and suitability of the building.
- d) a certificate from a pest control company, with regard to the presence of termites or borers.
- e) a statutory declaration to accompany photographs of all elevations of the dwelling stating that the pictures are a true representation of the dwelling and its current condition.
- f) Additional items for development application:
- g) A bond is payable at time of lodgement of application, as per Council's revenue policy.
- h) A copy of a public risk insurance policy which covers the transit of the building is to be submitted with the application. Such a policy shall be for not less than \$2 million.
- i) The requirements of the NSW Police, Roads and Traffic Authority, Integral Energy and any other statutory authority as appropriate are to be obtained and their requirements adhered to in the relocation of the subject building
- j) The building shall be completed to a satisfactory standard (as determined by Council Officers) within six months of being placed on the site. The electrical installation is to be inspected and approved by the local supplier.

A9.16 Property Address – Street and Rural numbering

- a) After completion of a building, the mailbox or building must be identified with letters or numerals with a minimum height of 38mm, of colour contrasting with the area of attachment.
- b) Kerbs: Letters and numerals to have a minimum height of 100mm.
- c) Rural numbering is to be fixed at the entry to the property and is available from council's offices.



A9.17 Unformed Roads

A9.17.1 Introduction

- a) Vehicular access to the site shall be provided in accordance with Council's Unformed Roads Policy. An application to construct the road under the Roads Act is to be made prior to the release of any development consent, with the road to be constructed prior to the occupation of the building. A copy of the policy follows.
- b) Safety Workers Compensation Insurance is to be held by the contractor for all employees engaged for works relating to the development that work within Council's roads and other public land. All vehicles and plant used shall be registered and covered by a third party personal and third party property insurance policy.
- c) Traffic Control/Safety Prior to any work commencing which affects Council's roads, the applicant is to notify Council and obtain relevant approvals. A traffic Management Plan, prepared by a suitably qualified consultant, may be required with the Development/Construction Certificate application.

A9.17.2 Policy for the Upgrading of Unformed Roads

If a landowner intends to gain vehicular access to their land along an unformed road, then the following conditions will apply:-

- a) A written application to conduct a formed road must be lodged, stating the reasons for the proposal.
- b) The application will be assessed, and written conditional approval may be granted:-
 - a. In the case of access to a single lot, the access to generally take the form of a 4m wide gravel surfaced road, with culverts, generally located in the centre of the road reserve. Steep grades will require sealing of the road and lining of table drains in accordance with normal standards.
 - b. In the case of access to multiple lots in the same ownership, the access will be conditioned as if the application was subdivision to create the existing lots.
- c) If an approval is given, standard conditions will apply, including:-
 - a. Normal engineering standards of road construction
 - b. Provision for traffic in accordance with the relevant Australian Standard
 - c. Approval by Council's Engineers of the contractor, following proof of the usual licences, insurances, etc
 - d. Approval by Council's Engineer of the materials and methods proposed to be used



- d) Following construction of the road in accordance with the conditional approval, and its acceptance by Council's Engineer, Council may assume responsibility for its maintenance after occupation of a dwelling served by the road only in residential or village zones.

A9.17.3 Background to the Policy

(a) Legal Framework

- i. The relevant legal framework is contained in the Roads Act 1993.
- ii. Council has no statutory duty to carry out works of construction or repair of public roads, or to keep them in repair.
- iii. It is an offence to carry out any work on a public road without the consent of Council. (Section 138)
- iv. Council can give this consent subject to conditions. (Section 139)
- v. Council can revoke this consent at any time and for any reason. (Section 140)
- vi. If the road is a Crown road rather than a public road, the relevant State Government Department will only permit its upgrading if Council will then accept it as a public road. Therefore, Council can impose identical conditions to those that would apply to a public road.

(b) The principles behind the policy are:-

- i. Council has an obligation to ensure that legal access is available to all lots. Council has NO obligation to provide physical access to lots.
- ii. The market value of a lot reflects the amenities which benefit the lot, such as water supply, sewerage, gas, sealed road access, etc.
- iii. Council should not be required to provide vehicular access at its cost as this is effectively subsidising the purchase price of the lot.
- iv. Owners of a lot on an unformed road who genuinely wish to build on the land should be able to do so at a reasonable cost, including the cost of provision of vehicular access.
- v. Council needs to minimize its exposure to subsequent complaints and requests for construction and sealing of the formed access road, by ensuring that it is built to an appropriate standard.



- vi. Owners or developers of multiple lots located on an unformed road who intend to develop and resell the lots should be required to provide access to a standard that would apply to subdivision. In such cases, the developer should be prevented from the sequential extension of the road and sale of the lots one at a time, by “bending” the policy.

(c) The intentions of the policy are:-

- i. To allow property owners to provide access to their land at reasonable cost.
- ii. To minimize requests for Council to further upgrade or maintain a road provided by a property owner.
- iii. To ensure that the effects on the environment are considered and adverse impacts minimised.
- iv. To ensure that de-facto land developers are required to provide a standard of road identical to that required by subdivision.



Section 10 Telecommunications and Radiocommunications Infrastructure

A10.1 Introduction

The following objectives and provisions apply to telecommunications and radiocommunications infrastructure (including broadcasting infrastructure covered under the *Telecommunications Act 1997* and the *Radiocommunications Act 1992*).

New telecommunications and radiocommunications infrastructure requires Council development consent, unless it is exempt by Commonwealth legislation such as the Telecommunications (Low Impact Facilities) Determination 1997 or is classified as exempt or complying.

As part of a carrier's consultation obligation for telecommunications and radiocommunications exempted by Commonwealth legislation, Council encourages a written submission demonstrating consistency with the objectives and provision below.

The following objectives and provisions do not apply to temporary emergency services or domestic satellite receivers.

A10.2 How do these provisions relate to Commonwealth legislation?

Telecommunications Act 1997 and Radiocommunications Act 1992

These provisions clarify the expectations of Council on carriers who operate under the *Telecommunications Act 1997* and *Radiocommunications Act 1992*.

Telecommunications Code of Practice 1997

These provisions clarify and standardise the expectations of Council in respect to land access situations.

Telecommunications (Low-Impact Facilities) Determination 1997 (LIF Determination)

While these provisions do not have the authority to override the LIF Determination, they nevertheless provide advice to carriers about the expectations of Council and require voluntary cooperation.

Code for the Deployment of Radiocommunications Infrastructure (ACIF, 2002)

These provisions broaden the scope of the ACIF Code by applying consistently to not only carriers and their agents, but also builders and operators of all RFR-Emitting infrastructure, including those operating under the *Radiocommunications Act 1992*. Consultation with Council is required under this code.



National Broadband Network (NBN Co) Rollout

The National Broadband Network is a wholly owned Government Business Enterprise (GBE) that is intended to provide a network of infrastructure to carriers at wholesale prices. This network will be constructed using a combination of fixed wireless, optical fibre and satellite communications devices to connect residences and businesses. Most of the infrastructure will be exempt under the *Telecommunications (Low Impact Facilities) Determination 1997*. As a public authority the balance will be exempt under the *NSW Infrastructure SEPP*.

A10.3 Objectives

This Section identifies Council's social and environmental objectives with regard to the development of telecommunications and radiocommunications infrastructure within Wingecarribee Shire.

A10.3.1 Social

- (a) To ensure that the general public and local communities have connection to up-to-date telecommunications technology
- (b) To apply the *precautionary principle* through prudent location of telecommunications and radiocommunications infrastructure to:
- (c) To Minimise EMR (Electro-Magnetic Radiation) exposure to the public
- (d) Avoid or minimise impacts on sensitive surrounding land uses, particularly with regard to visual impact.
- (e) To achieve equity for all stakeholders by endeavoring to balance their various needs of access, EMS Potential, visual impact and service provision.
- (f) To provide mechanisms by which information can be disseminated to ensure that community is adequately informed and empowered to participate in the planning/decision making process.

A10.3.2 Environmental

- (a) To help implement principles of urban design in respect to telecommunications and radiocommunications infrastructure
- (b) To promote good industrial design of infrastructure
- (c) To provide infrastructure that is visually compatible with surrounding character and locality/visual context with particular regard to heritage buildings/areas and cultural icons.



- (d) To prevent any adverse impact on the natural environment
- (e) To restore the site after discontinuation or removal of infrastructure

A10.4 Controls

A10.4.1 Australian Standards

All facilities are required to comply with relevant Australian standards, including EMR standards.

A10.4.2 Visual Amenity

Carriers are to design antennas and supporting infrastructure in such a way as to minimise or reduce visual and cumulative visual impact from the public domain and adjacent areas.

A10.4.3 Infrastructure must;

The infrastructure design will respect the amenity of the local context, particularly ensuring that such development shall:

- (a) Be appropriate in colour, texture, form, bulk and scale.
- (b) Be well designed
- (c) Be integrated with the existing building structure unless otherwise justified to Councils satisfaction.
- (d) Have concealed cables where practicable and appropriate
- (e) Be unobtrusive where possible
- (f) Be consistent with the character of the surrounding area.
- (g) be removed when it is no longer being used for transmission.
- (h) The site must be restored and rehabilitated following construction of the infrastructure.
- (i) Demonstrate compliance with the provisions of Section A10.5 to A1.11

Note:

Landlord requirements are not considered adequate justification for non-compliance



A10.5 Co-Location Requirements

Co-Location is the practice of locating a number of different telecommunications facilities, often owned by different carriers, on one facility or structure.

- (a) Where co-location of telecommunications facilities are proposed the impact of the development is to be assessed against:
 - (i) Cumulative emissions of all co-located telecommunications facilities;
 - (i) Visual impact of co-located telecommunications facilities
 - (ii) The physical and technical limits to the amount of infrastructure that masts and towers are capable of supporting; and
 - (iii) Whether the required coverage can be achieved from the location
- (b) Carriers shall demonstrate a precautionary approach and effective measures to minimise the negative impacts of co-location

A10.6 Location

- a) The applicant must demonstrate that, in selecting a site, it has adopted a precautionary principle approach to minimising EMR exposures consistent with Section 1.5 of the ACIF Code.
- b) The preferred location for telecommunications and radiocommunications infrastructure is industrial areas, low use open space and commercial centres, rural areas and infrastructure corridors such as railways and highways.
- c) Radio Communications and Telecommunications facilities are to be located a minimum distance of 100 metres from residences where they are to be installed in residential areas. In setting this distance Council supports the precautionary approach to protect residential amenity.
- d) The proposal is to avoid or minimise the physical impact of any facility on endemic flora and fauna habitats.
- e) The proposal is to avoid or minimise the visual impact on heritage significance of adjacent, adjoining or surrounding heritage items or conservation areas listed in Wingecarribee LEP 2010
- f) The applicant shall demonstrate particular consideration of sensitive land uses especially where a telecommunications or radiocommunications facility is proposed that is not ancillary to its primary function (see co-location above) Sensitive land uses include:



- g) Where occupants are located for long periods of time (eg, Residents).
- h) That are frequented by young children (eg, schools and child care centres) and
- i) Where there are people with particular health problems (Hospitals and child care centres)

A10.7 Physical Design

- (a) Infrastructure must be of high quality design and construction.
- (b) Proposals should consider the range of available alternative infrastructure including new technologies to minimise unnecessary or incidental EMR emissions and exposures, as required by Section 5.2.3 of the ACIF Code
- (c) The plan for the facility must include measures to restrict public access to the antenna(s). Approaches to the antenna must contain appropriate signs warning of EMR and providing contact details for the facility's owner/manager.
- (d) The minimum requisites that shall apply where relevant are the BCA and the relevant Australian standards. The applicant must provide Council with certification to demonstrate compliance with the BCA and other standards

A10.8 Public Health

- (a) The applicant is to demonstrate the precautions it has taken to minimise EMR exposures to the public.
- (b) The applicant is to provide documentation to show that the proposed facility complies with the relevant Australia exposure standard.
- (c) The applicant is to provide a mapped analysis of the cumulative effect of the proposal.
- (d) A Community Consultation Plan is required for all proposals requiring Council consent detailing how the consultation is to be conducted and how the results will be forwarded to Council

A10.9 A1.10 Environmental Impacts

- (a) This clause applies to land zoned E2 Environmental Conservation, E3 Environmental Management and E4 Environmental Living
- (b) Development to which this clause applies requires development consent.
- (c) The applicant is to avoid or minimise the physical impact of any proposed facility on the visual aspect of a location.



-
- (d) New installations should consider the use of renewable energy sources to minimise the need for connection to the conventional power grid (particularly in remote locations), so that such installations are self sufficient in terms of energy supply and to reduce the reliance on conventional power sources.

A10.10 Heritage Impacts

- (a) The applicant is to provide a heritage report/impact assessment where the installation of infrastructure may impact upon a heritage item or property located in a conservation area.



Part B

Development- Specific Controls



THIS PAGE INTENTIONALLY BLANK



PART B DEVELOPMENT- SPECIFIC CONTROLS

Section 1 Introduction

Part B of the DCP provides detail on additional objectives and controls applicable to specific types of development permissible with consent in the zones to which this Plan applies. These controls are additional to those contained in Part A.

The following Sections deal with development types as indicated:

Section 2: Residential and Ancillary Development – including residential accommodation, ancillary bed and breakfast establishments and home based businesses.

Section 3: Agriculture and Ancillary Development – including intensive livestock and plant agriculture, aquaculture and ancillary development such as farm buildings and farm stay accommodation.

Section 4: Rural and extractive Industry– including produce and processing industries, forestry, mining and extractive industry.

Section 5: Tourist-related Development – considers development permissible with consent in the SP3 Tourist zone

Section 6: Commercial & Community-related Development – various forms of commercial development, animal boarding & training establishments, and community-related development.

Section 2 Residential and Ancillary Development

B2.1 Siting, Design and Landscaping of Residential Development

B2.1.1 Introduction

Historically, residential buildings were usually situated to provide shelter from the elements, such as on flat land, or on the mid slopes of hills to provide some outlook without over-exposure to the elements. More recent residential development however has tended to be sited along ridge lines to take advantage of views.

Such siting of development will no longer be accepted by Council. Not only do ridge line developments intrude unnecessarily on the natural landscape, they expose such development to the strong winds which characterise the climate of the Southern Highlands resulting in more reliance on artificial heating with associated energy demands, or wind protection through the planting of unsuitable tree species, than would be the case if a more protected site were selected.







B2.1.2 Objectives for the Siting of Residential Development

In assessing an application for residential development in a rural area, Council will consider the extent to which the following objectives have been addressed:

- (a) development is responsive to the scenic and historic landscapes of the Shire.
- (b) development recognises, protects and promotes the scenic qualities of its immediate and wider setting. Rural developments must respect the landscape setting, not attempt to dominate it.
- (c) scenic resources and values of the Shire are recognised and protected with regard to existing and future tourism potential, particularly in relation to any views and vistas from a public place.
- (d) landscape features such as prominent ridge lines, hill tops, horizons, slopes and topographic features that are prominent when viewed from a public place are protected from the siting and design and landscaping of rural development that conflicts with their prominence and scenic qualities.
- (e) dominant scenic character and quality of the Shire are maintained by ensuring that new developments are located designed, coloured and landscaped in a way that complements the existing and desired future character of the area in which they are situated.
- (f) developments are landscaped in a way that complies with the definition and standards of a *vegetative barrier planting* and is compatible with and which complements and enhances the scenic quality and historic character of the locality, using plant species that are appropriate to the natural and cultural landscape features.
- (g) siting of rural development leads to appropriate outcomes for the community while considering the privacy and amenity of adjacent property owners.
- (h) development proceeds in a manner that recognises the principles of Ecologically Sustainable Development. This includes relevant issues such as the siting of development in a manner that limits exposure to the elements.

In order to assess the extent to which these objectives are addressed, Council will apply the following performance standards to the application.

B2.1.3 Performance Standards - Development Location

- (a) Development will be placed in locations on the land where visual impacts on views, features such as ridge lines, hill tops, horizons, prominent slopes and topographic features will be minimised, when these are viewed from a public place.



- (b) The visual impact of buildings with respect to siting and visibility will be assessed from all locations from which they are reasonably capable of being viewed (its visual catchment). A building will generally be acceptable if it has a low impact on its overall visual catchment, provided that it does not have significant impacts on individual viewing places of a public place or Heritage Conservation areas.
- (c) The visual impact of buildings will vary between viewing locations and some will be more affected than others. In the case of higher impacts that are confined to an individual or a small number of places, an application must still demonstrate that the impact does not unacceptably impact on that place. A building may not be permitted that has an impact on only one viewing location, if that location is judged to be of sufficient significance.
- (d) Buildings shall be responsive to the landscape character and scenic features of the locality in which they are situated. Different approaches to design, siting and landscape will be appropriate to areas with predominantly pastoral character compared with others characterised by native vegetation.
- (e) Where there are two or more buildings, for example homes, sheds and ancillary buildings, they will be clustered to reduce the space that they occupy and be landscaped to reduce their accumulated impacts. Building groups that spread across the landscape and increase the visibility and bulk of the built form will not be permitted. Replacement buildings are to be sited in a location that complies with this DCP. The existing siting of a building that is to be demolished may not be approved for the siting of a new building.
- (f) Rural Developments shall be sited so that they do not impact upon horizons. Buildings that are sited so that they project partly or wholly above the horizon and are seen against the skyline from a public place are generally not permitted.
- (g) Buildings that would be situated close to the horizon must be vertically separated from it to the extent that the background horizon and the elements that comprise it, for example natural features, topography, vegetation and so on, remain the dominant scenic feature of the horizon. Buildings will be preferred if placed in traditional relationship to the landform and topography. Typically, rural buildings are sited on lower and mid-slopes, on benched areas below horizons and hill tops and away from cold valley floors. Buildings sited in these ways are generally acceptable.

B2.1.4 Performance Standards - Landform and Vegetation Modification

- (a) Rural Development shall make use of existing natural topography and vegetation to provide an appropriate visual setting. Landform modified by cutting and filling, grading and retained earth works is permitted within Council's specified limitations.



- (b) Rural Development shall be accessed in ways that minimise impacts on views from public places, prominent landscape features, existing vegetation and culturally significant landscapes. Access that requires extensive earth works, cut and fill, retaining structures and removal of natural vegetation will generally not be permitted.
- (c) Rural Development shall respond to the existing pattern of remnant and cultural vegetation in siting and in the mitigation of visual impacts. Buildings that are sited so as to retain existing vegetation and which use it, whether with or without addition of new vegetation, to provide an appropriate setting or screen, are generally acceptable.
- ~~(d)~~ Rural Development shall not require the clearing of native vegetation or established cultural plantings if this results in an increase in the prominence or visibility of the building from a public place or within a Heritage Landscape Conservation Area.
- (e) Rural Development shall be appropriately landscaped if necessary, with either indigenous native species or appropriate cultural plantings, to provide amenity and, screening of views from any viewing directions and to reduce the apparent scale of buildings in relation to horizons, hill tops or ridge lines. Landscaping may be required to screen development from privately owned places.

B2.1.5 Performance Standards - Building Design, Materials and Colours

- (a) Buildings shall be of a mass and scale that is responsive to the need to minimise visual impacts on rural landscapes.
- (b) Buildings that are visible from a public place or in the context of scenic features such as ridge lines, hill tops, horizons, prominent slopes and topographic features, or heritage items and landscapes, shall be of forms that have the effect of minimising their bulk.
- (c) Buildings shall minimise their impacts on views, if necessary, by being composed of appropriate materials. Appropriate materials are either natural components of the environment such as local stone and timber or materials capable of being finished and coloured in a way that minimises their prominence in views.
- (d) Buildings shall have roof materials, where necessary, that minimise visibility and prominence of the roof plane and surfaces. In general, roofs of slate, tile and steel or other metal materials in appropriate colours will be permitted. Plain galvanised steel may be permitted if a glare nuisance is not anticipated and it is proven that the material will not be visually obtrusive from any public place. Treatments to dull the glare may be required by Council. Zinalume and unpainted aluminium roofing will not be permitted.



- (e) Buildings that are in prominent locations will be coloured in ways that reduce their visibility and help to blend into the existing natural and cultural landscape. Variations in colour between wall and roof and variations in colour of details is encouraged. Colours that emulate natural materials or earthy colours and that are darker will generally be permitted. Other colour schemes will be assessed on their merits.

B2.1.6 Performance Standards - Landscaping

- (a) Where a site has a frontage to a public road exceeding 50 metres in length, a Concept Landscape Plan shall be submitted with the Development Application, specifically detailing the plantings around the boundary of the property and demonstrating compliance with the controls for vegetative barrier planting contained in Part A.
- (b) Where landscape is designed to blend the building into the visual setting of an area featuring remnant native vegetation, the species will be chosen from indigenous native species and the planting designed to provide a natural vegetation structure including shrubs, small and larger trees. Landscape schemes for these contexts that rely totally on ornamental species will not generally be permitted.
- (c) In landscape types predominantly of a pastoral character, landscape will reflect the predominant cultural plantings associated with farm buildings, homesteads and windbreaks. Buildings proposed with no amenity or ornamental landscape surrounding them will generally not be permitted.
- (d) Screen planting shall not be relied upon as a sole means of mitigating the visual impact of rural development located on land where visual impacts on views, features such as ridge lines, hill tops, horizons, prominent slopes and topographic features will occur, when these are viewed from a public place. For example, buildings that are screened solely from the road by windbreak plantings or avenues will not be permitted. Plantings that do not comply with the requirements for vegetative barrier planting will not be permitted.
- (e) Landscape will not be required in order to hide buildings from sight, provided those buildings are located to respond appropriately to the locality and minimise visual impacts in other ways. Generally, it will be Council's opinion that if a rural development needs to rely on screening by vegetation to improve its appearance in the landscape, than the development is inappropriately sited in the first place and will not be permitted.



B2.2 Energy Efficient Building Design

Referral to the BASIX (Building Sustainability Index) website (www.basix.nsw.gov.au) is compulsory for all dwelling developments within NSW. These requirements apply to detached, attached and multi dwelling housing, either in the form of new development or alterations and additions to existing development with a value at or over \$100,000.

A BASIX Certificate must be obtained and lodged with the Development Application and/or Complying Development Certificate. The BASIX Certificate lists all the commitments the applicant has agreed to, and the Certifying Authority will check these at various stages of construction.

There are three main categories under BASIX – water, thermal comfort and energy, and many alternative ways to comply with the BASIX requirements with options such as rainwater tanks, water-saving fixtures, improved insulation, passive solar orientation, natural lighting and native plants for gardens.

B2.3 Dual Occupancy and Secondary Dwelling Developments

B2.3.1 Introduction

Dual occupancy and Secondary Dwelling developments offer increased housing choice within rural areas, providing a level of independent living for both younger and older family members, as well as for guests. However, it is important to ensure that such development does not adversely impact on rural localities stimulating an increase in the number of independent dwellings scattered across the landscape.

WLEP 2010 defines dual occupancy as “2 dwellings (whether attached or detached) on one lot of land (not being an individual lot in a strata plan or community title scheme), but does not include a secondary dwelling.”

WLEP 2010 defines a Secondary Dwelling as “a self-contained dwelling that:

- (a) is established in conjunction with another dwelling (the principal dwelling), and
- (b) is on the same lot of land (not being an individual lot in a strata plan or community title scheme) as the principal dwelling, and
- (c) is located within, or is attached to, or is separate from, the principal dwelling.”

WLEP 2010 also provides that the total floor area of the dwelling (excluding any area used for parking) shall not exceed sixty (60) m², or 33% of the floor area of principal dwelling, whichever is the greater.



Applicants are reminded that, although the land use table in WLEP permits, with consent, development for the purposes of a dwelling house, attached dual occupancy, secondary dwelling and farm stay accommodation in the rural and environmental zones, applications for such development will be assessed on their merits to ensure that the objectives of the zone and the environmental amenity of the locality are not compromised.

The options for Dual Occupancy and Secondary Dwelling development in the RU1 Primary Production, RU2 Rural Landscape, E3 Environmental Management and SP3 Tourist zones are:

- a) On a minimum lot area of 1,000m², Dual Occupancy (Attached) is permitted with consent, to be located within 50 metres of the principal dwelling, or
- b) On a minimum lot area of 1,000m², a Secondary Dwelling as defined under WLEP 2010, is permitted with consent, to be located within 50 metres of the principal dwelling.

B2.3.2 Objectives

In assessing an attached dual occupancy or a secondary dwelling development Council will consider the extent to which the following objectives are addressed:

- (a) The development ensures a high level of amenity, both for it and for the principal dwelling.
- (b) No adverse impact on the character of a rural area will occur through any dual occupancy or secondary dwelling development.
- (c) The cumulative effects of dual occupancy or secondary dwelling development, both on the subject site, or within the vicinity.

B2.3.3 Development Controls

- (a) Each dwelling shall have its own independent access.
- (b) In assessing a dual occupancy or secondary dwelling application Council will take into consideration the following matters:
 - (i) environmental impacts,
 - (ii) visual impacts; particularly with regard to the combined bulk and scale of both the principal dwelling and the dual occupancy or secondary dwelling development;
 - (iii) building materials and potential for reflection;
 - (iv) noise attenuation and privacy;
 - (v) energy efficiency;



- (vi) access to potable water;
 - (vii) suitability of site for on-effluent disposal;
 - (viii) lighting and spillage;
 - (ix) landscaping and screening;
 - (x) on-site parking and vehicular access.
- (c) A secondary dwelling which is separate from the principal dwelling shall be located no more than 50 metres from the principal dwelling so that the effect of the relative locations is to create a 'group' of buildings.
- (d) A secondary dwelling which is separate from the principal dwelling shall be designed to be compatible with the design of the principal dwelling, particularly with regard to design, materials, colour, finish, roof treatment and roof pitch.
- (e) Notwithstanding any other provision of this Plan, a secondary dwelling within the Berrima Landscape Conservation Area shall only be located within or attached to the principal dwelling. No secondary dwelling which is separate from the principal dwelling shall be permitted in the Berrima Landscape Conservation Area.

B2.4 Tennis Courts

Tennis courts are to be designed and sited to ensure potential impacts upon the environment, neighbours and existing rural character are minimised. In particular, lighting and external noise issues are to comply with the requirements of Part A of this Plan.

B2.4.1 Development Controls

- (a) The design and placement of tennis courts must ensure a minimum disturbance to the natural environment.
- (b) The siting of tennis courts and surrounding landscaping in the rural areas will not adversely alter or interfere with natural drainage flows and patterns, or with existing native vegetation and habitat.
- (c) All significant natural and cultural features on site are retained through the construction and development process.
- (d) The siting of tennis courts must be undertaken to minimise cut and fill requirements.
- (e) The operation of tennis courts shall comply with the lighting and external noise requirements contained in Part A of this Plan.



B2.5 Domestic Water Supply

Due to the unpredictable nature of the rainfall, the rural areas of Wingecarribee Shire are periodically affected by drought conditions. To assist in managing drought times, current recommendations are for applicants to install as many tanks as is practicable for the catchment and storage of rain water.

B2.5.1 Development Controls

- (a) A 100,000L rain water tank shall be installed for domestic use only. It is strongly advised that a total domestic water storage capacity of greater than 100,000 L be installed.
- (b) A tank is to include any prefabricated or modular device designed for the storage of rainwater.
- (c) The tank must be designed to capture and store roof water from gutters and down pipes.
- (d) A minimum of 50% of the roof area must be connected to the rainwater tank.
- (e) The tank must be located behind the building line setback to any street and where visible from a street shall be suitably screened with vegetation or a trellis.
- (f) The tank must not be installed over an easement or other encumbrance or within the zone of influence of any Council main.
- (g) The tank and any tank stand must be structurally sound. The height of any tank including tank stand shall not exceed 2.4m above natural ground level without separate Council approval.
- (h) The tank shall not be constructed of any reflective materials.
- (i) Overflow from the tank shall be directed to an existing stormwater system where it is deemed appropriate for the overflow.
- (j) The tank inlet shall be screened or filtered and the tank maintained to prevent mosquitoes breeding.
- (k) Any motorised or electric pump associated with the tank shall not cause a noise nuisance.
- (l) If the rainwater tank is to be used for human consumption, the tank is to be installed and maintained in accordance with the NSW Health publication titled 'Guidance on the use of Rainwater Tanks, 1998' including the fitting of a first flush diversion device.



B2.6 Water Supply for Rural Fire Service

B2.6.1 Introduction

Some areas of the Shire are affected by Bushfire Hazard ratings that require applications for rural development to have the concurrence of the Rural Fire Service. As a part of this concurrence the Rural Fire Service may require the installation of water tanks devoted only for fire fighting purposes. These tanks will need to be fitted with appropriate attachments to ensure that they are compatible with fire fighting equipment and dedicated only for fire fighting purposes.

B2.6.2 Development Controls

- (a) At least one 10,000L water tank, designated for the exclusive use for fire fighting purposes, is to be installed and fitted with a 65mm storz fitting and ball gate valve.
- (b) Provision must be made for the access of a heavy fire fighting tanker to within 4m of this designated static water supply.
- (c) This water supply is to be clearly labelled for “fire fighting purposes” only.

B2.7 On-Site Effluent Disposal System

B2.7.1 Introduction

Applications for rural development will require an appropriately designed and installed on site effluent disposal system. Due to the large variation in soil types, topography, slope and proximity to water courses, applications for rural development will need to be accompanied by a Water Cycle Management Study carried out by an appropriately qualified professional. Applicants are directed to Section A5.2 of this Plan for further detail in this regard.

B2.7.2 Objectives

- (a) That an appropriate on-site effluent disposal system is designed to be site specific by a qualified professional.
- (b) That any on-site effluent disposal system ensures that it complies with all of the relevant requirements from the SCA and REP 1.

B2.7.3 Development Control

- (a) A Water Cycle Management Study must be prepared by an appropriately qualified professional.
- (b) The Water Cycle Management Study must include the following components:



- (i) A clear outline of the proposed development, including a detailed site plan which includes site constraints,
- (ii) A summary of the water quality control measures proposed as part of the development and their location,
- (iii) A statement, based on the information in the Water Cycle Management Study, as to whether the development has a neutral or beneficial effect on water quality, consistent with the SCA's Neutral or Beneficial Effect on Water Quality Assessment Guidelines.

B2.8 Shipping Containers

The installation of shipping containers on any site shall be prohibited except on land zoned RU1 and RU2 where one (1) container may be located under the provisions of State Environmental Planning Policy (Exempt and Complying Codes) 2008 ('the Codes SEPP'.)

B2.9 Group Homes (Permanent or Transitional)

B2.9.1 Introduction

Permanent and Transitional Group Homes are permissible with the consent of Council in the zones to which this DCP applies. Applicants are directed to the definitions for such Homes contained in the WLEP 2010. It should be noted that Group Homes do not include development to which *State Environmental Planning Policy Housing for Seniors or People with a Disability* applies.

B2.9.2 Controls

In addition to all relevant controls relating to the siting, design and assessment of residential buildings in the rural areas, the following controls apply:

- (a) That all relevant standards outlined by relevant state government authorities are incorporated into the design and construction of any group home.
- (b) That the impact on adjoining neighbours is taken into consideration in the design and siting of group homes.



B2.10 Bed and Breakfast Accommodation

B2.10.1 Introduction

Bed and Breakfast Accommodation is permissible with consent in all the zones to which this DCP applies. Under WLEP 2010, Bed and Breakfast Accommodation is defined as *tourist and visitor accommodation comprising a dwelling (and any ancillary buildings and parking) where the accommodation is provided by the permanent residents of the dwelling and:*

- (a) meals are provided for guests only, and*
- (b) cooking facilities for the preparation of meals are not provided within guests' rooms, and*
- (c) dormitory-style accommodation is not provided.*

Clause 5.4 (1) of WLEP limits the number of bedrooms to three (3).

Under the SEPP (Exempt and Complying Development Codes) 2009, the maximum floor area for a dwelling being used as a Bed and Breakfast Accommodation is 300m². The following objectives and controls apply to proposals in excess of this maximum. They also apply to either new development for the purposes of a Bed and Breakfast establishment, or the conversion of an existing dwelling to provide bed and breakfast accommodation.

Because such development can impact on the amenity of a rural area, particularly through additional outbuildings associated with the development as well as traffic and car parking implications, the assessment of an application will take into consideration the degree to which the proposal is compatible with the existing and desired future amenity and character of the area.

B2.10.2 Objectives

The controls described below are intended to achieve the following objectives:

- (a) To provide low scale tourist accommodation throughout the Shire.
- (b) To ensure that Bed and Breakfast Accommodation operates only as an ancillary function to that of a dwelling house.
- (c) To ensure that the dwelling, although accommodating a secondary use, maintains its residential scale and appearance when assessed against surrounding dwellings.
- (d) To ensure that the development, including outbuildings and parking areas, remains essentially residential in character and reflects the rural character of development in the surrounding area.
- (e) To ensure that Bed and Breakfast Accommodation operates in accordance with relevant industry standards.



- (f) To ensure that appropriate health and fire safety standards are satisfied and maintained.

B2.10.3 Development Guidelines

- (a) The Local Government and Shires Association of NSW has published a document titled "Guidelines for Bed and Breakfast Operations – Best practice assessment and policy guidelines for use by Local Government and the Bed and Breakfast industry in NSW". It is advisable to obtain a copy of these guidelines to assist in designing and establishing your Bed and Breakfast Establishment.
- (b) It is further advised that you contact the Bed and Breakfast Council of NSW for advice on best practice industry standards.
- (c) name of the operator of the establishment.
- (d) When lodging a development application, the following information is to be provided:
 - (i) site analysis as described in Part A.
 - (ii) plans of the existing dwelling house, indicating all internal uses including the permanent residents' accommodation and the number (maximum three (3)) and location of proposed guest rooms.
 - (iii) The location and dimensions of additional buildings other than the principal dwelling, and car parking areas on site.

B2.10.4 Development and Design Controls

To achieve the objectives described above and address the development guidelines, the development shall comply with the following controls (subclauses B2.9.4 to B2.9.7 inclusive):

- (a) Overnight accommodation shall be contained wholly within the principal dwelling.
- (b) Ancillary development provided as part of the Bed and Breakfast facility, such as recreation rooms, gazebos, indoor swimming pool, shall be located on the same lot as the principal dwelling.
- (c) Ancillary development provided as part of the Bed and Breakfast facility, such as recreation rooms, gazebos, indoor swimming pool, shall be of a scale that ensures that the principal dwelling remains the primary land use on the site and that residential development remains the dominant land use in keeping with the rural surroundings.
- (d) In submitting an application for Bed and Breakfast Accommodation within a building which has previously been used for non-residential purposes (such as



a barn or church conversion), the owner must demonstrate to Council that the premises can remain as a principal place of residence if the bed and breakfast facility subsequently ceases to operate.

B2.10.5 Operational Controls

- (a) The proprietor and operator of a dwelling offering Bed and Breakfast Accommodation must be the owner of the property and must be a permanent resident of the property.
- (b) The Bed and Breakfast Accommodation must be for short-term guests occupying the premises for a maximum of one calendar week at a time.
- (c) No more than 12 persons shall be accommodated in the dwelling at any one time including permanent residents, guests, friends or family to ensure that the building does not result in higher order classification under the Building Code of Australia.
- (d) A maximum of three (3) bedrooms shall be available for guests.
- (e) Guest bedrooms shall accommodate a maximum of two persons per room.

B2.10.6 Access for the Disabled

New or altered Bed and Breakfast Accommodation must consider the needs of disabled persons through the following measures:

- (a) Access to dwellings should be direct and without unnecessary barriers.
- (b) Stairs and ramps should have reasonable gradients and non-slip, even surfaces.
- (c) The principal point of entry and a bathroom accessible to guests should be designed for disabled access, in accordance with current Australian Standards for the Design for Access and Mobility.
- (d) At least one car parking space should be designed for disabled access, in accordance with current Australian Standards for Parking Facilities.

B2.10.7 Car Parking

Safety and convenience are the principal parking and access issues. Entering and leaving Bed and Breakfast Accommodation should be safe for visitors, other road users and pedestrians who may be unfamiliar with the establishment. Parking is to be convenient for visitors without inconveniencing adjoining neighbours or other road users.

To meet these requirements, the following controls apply:



- (a) A traffic and parking impact statement is required to be submitted to Council as part of the development application.
- (b) In addition to permanent resident parking, on site car parking must be provided at the rate of one (1) space per guest bedroom plus one (1) space per two (2) employees.
- (c) On-site car parking shall be constructed and located so as to minimise the noise of vehicles entering and leaving the site.
- (d) No more than 50% of the property located between the main building and the front property boundary shall be occupied by off-street car parking spaces, including access driveways. Such space shall be suitably screened with appropriate landscaping.
- (e) The minimum size for car parking spaces is 5.5m x 2.5m (open parking). Minimum internal dimensions of a single lock up garage are to be 3m x 5.5m unobstructed, with any car access opening being at least 2.4m wide.
- (f) Vehicles are to enter and leave the property in a forward direction.
- (g) At least one (1) car parking space should be designed for disabled access, in accordance with the relevant Australian Standard for Parking Facilities.

B2.11 Home Business

B2.11.1 Introduction

Home-based businesses provide a valuable opportunity for rural residents to undertake work from home, offering both local employment and local services. The following controls are intended to maintain those opportunities while ensuring that there are no detrimental effects in terms of environmental or residential amenity.

Home Business is defined within WLEP 2010 as:

a business carried on in a dwelling, or in a building ancillary to a dwelling, by one or more permanent residents of the dwelling, provided that activity does not involve:

- (a) *the employment of more than 2 persons other than those residents, or*
- (b) *interference with the amenity of the neighbourhood by reason of the emission of noise, vibration, smell, fumes, smoke, vapour, steam, soot, ash, dust, waste water, waste products, grit or oil, traffic generation or otherwise, or*
- (c) *the exposure to view, from any adjacent premises or from any public place, of any unsightly matter, or*
- (d) *the exhibition of any notice, advertisement or sign (other than on that dwelling to indicate the name of the resident and the business carried on in the dwelling), or*



- (e) *the sale of items (whether goods or materials), or the exposure or offer for sale of items, by retail, except for goods produced at the dwelling or building,*

WLEP 2010 also requires that the carrying on of the business must not involve the use of more than 100 square metres of floor area.

The definition excludes Bed and Breakfast Accommodation (for which separate provisions are found in this DCP in B2.9 above), or Home Occupation (sex services) which is prohibited throughout the Shire.

B2.11.2 Objectives

In setting controls for Home Business, Council seeks to achieve the following objectives:

- (a) To offer opportunities for home businesses in appropriate locations in the rural areas.
- (b) To ensure that any home business is compatible with neighbouring land uses.
- (c) To ensure that the activities of the home business do not have an adverse impact on environmental or rural amenity.
- (d) To ensure that home businesses provide adequate safe access /egress and parking for visitors/users.

B2.11.3 Development Controls

Council shall not approve an application for a Home Business unless it is satisfied that:

- (a) The application complies with the WLEP 2010 control of a maximum area of 100 square metres.
- (b) All applicable siting and design objectives and controls have been considered and addressed.
- (c) All controls applicable to the construction and ongoing operation of the business have been considered and addressed.
- (d) The application complies with industry standards, including energy efficiency and accessibility;
- (e) All appropriate health and fire safety standards have been considered and addressed.
- (f) Adequate parking is provided for the business in addition to at least one space being available for the principal dwelling;
- (g) All parking is constructed and located to minimise the potential for any noise nuisance of vehicles entering and leaving the site;



- (h) Parking spaces, manoeuvring areas and driveways are located away from prominent views with minimal impact on the landscaping of the site.
- (i) Parking spaces are screened within appropriate landscaping;
- (j) The business undertaking does not conflict with adjoining agricultural uses.
- (k) Clear emergency evacuation procedures are displayed in any ancillary building used for the home business.
- (l) A fire prevention and management plan has been prepared and is displayed in a prominent location in any ancillary building used for the home business.

B2.12 Home Industry

B2.12.1 Introduction

Home industries provide valuable opportunities for rural residents to undertake work from home, offering both local employment and local services. The following controls are intended to maintain those opportunities while ensuring that there are no detrimental effects in terms of environmental or residential amenity.

B2.12.2 Objectives

In setting controls for home industry, Council seeks to achieve the following objectives:

- (a) To offer opportunities for home industries in appropriate locations in the rural areas.
- (b) To ensure that any home industry is compatible with neighbouring land uses.
- (c) To ensure that home industries provide adequate safe access /egress and parking for visitors/users.
- (d) To ensure that the activities of the home industry do not have an adverse impact on environmental or rural amenity.

B2.12.3 Development Controls

Council shall not approve an application for a Home Business unless it is satisfied that:

- (a) The application complies with the WLEP 2010 control of a maximum area of 100 square metres.
- (b) All applicable siting and design objectives and controls have been considered and addressed.
- (c) All controls applicable to the construction and ongoing operation of the industry have been considered and addressed.



- (d) The application complies with industry standards, including energy efficiency and accessibility;
- (e) All appropriate health and fire safety standards have been considered and addressed.
- (f) Adequate parking is provided for the activity in addition to at least one space being available for the principal dwelling;
- (g) All parking is constructed and located to minimise the potential for any noise nuisance of vehicles entering and leaving the site;
- (h) Parking spaces, manoeuvring areas and driveways are located away from prominent views with minimal impact on the landscaping of the site.
- (i) Parking spaces are screened within appropriate landscaping;
- (j) The activity does not conflict with adjoining agricultural uses.
- (k) Clear emergency evacuation procedures are displayed in any ancillary building used for the home industry.
- (l) A fire prevention and management plan has been prepared and is displayed in a prominent location in any ancillary building used for the home industry.

B2.13 Health Consulting Rooms

Health Consulting Rooms are defined in WLEP 2010 as “a medical centre that comprises one or more rooms within (or within the curtilage of) a dwelling house used by not more than three health professionals who practice in partnership (if there is more than one such professional) who provide professional health services to members of the public.”

Health Consulting Rooms are permissible with consent in zones RU1 Primary Production, RU2 Rural Landscape and E3 Environmental Management.

B2.13.1 Development Controls

In assessing an application for Health Consulting Rooms, Council will ensure that the proposed development :

- (a) provides a site analysis as described in Section B2 of this Plan.
- (b) demonstrates that health and safety impacts of the proposal have been considered in the design, construction and ongoing running of the rooms.
- (c) demonstrates that the environmental impacts have been considered in the design, construction and operation of the associated Health consulting rooms.
- (d) demonstrates that the proposal will be able to operate in accordance with industry standards and controls set by relevant Government agencies.



-
- (e) makes adequate provision for on-site car parking, constructed and located to minimise the potential for any noise nuisance to surrounding properties of vehicles entering and leaving the site;
 - (f) ensures that parking spaces, manoeuvring areas and driveways are located away from prominent views and must have minimal impact on the landscaping of the site.
 - (g) ensures that parking spaces are screened with appropriate landscaping;
 - (h) ensures that their proposal does not create potential conflict with adjoining agricultural uses.



Section 3 Agricultural and Ancillary Development

B3.1 Introduction

This section of the Plan relates to all forms of Agriculture and ancillary development permissible within the zones to which this Plan applies, namely:

B3.2 Protection of Rural Lands for Future Agricultural Uses

In line with current State Government Policy, Council is committed to retaining rural lands for current and future agricultural land uses. Rural land in the Shire is a highly valued commodity, not just for the Shire, but for the state as a whole: *“Agricultural lands in the Region should not just be seen in terms of their current values, as the Region is strategically placed for the long term food production” (Sydney Canberra Corridor Regional Strategy).*

In other words, the future value of rural land is in its ongoing agricultural capacity, rather than in any perceived value for future residential development. The Regional Strategy sets the framework in which Council is to protect and maintain its rural lands for current and future emerging agricultural land uses and highlights that the Shire is well placed to fulfill an important agricultural function, both in terms of land suitability and climate, and proximity to markets.

Government Departments such as the NSW Department of Primary Industries (NSW DPI) and the Sydney Catchment Authority (SCA) have collated or produced excellent detailed and highly practical information on recommended best practices for agricultural land uses. The Department of Primary Industries also runs subsidised short courses to assist land owners and managers to implement appropriate land management practices which promote profitable and sustainable agricultural enterprises. NSW DPI also provides access to appropriate land management professionals including agronomists and livestock officers to assist in the planning and implementation of best management practices.

Land owners and managers are strongly encouraged to attend relevant courses and further information both on the courses and on best practice methodologies can be found on the Department’s web site at <http://www.profarm.com.au>. Similarly, the Sydney Catchment Authority (SCA) also collates a range of current recommended practices that need to be incorporated into any activities. Further information on these can be found on the SCA website.

All applicable ‘Best Practice Methodologies’/ ‘Current Recommended Practices’ must be employed by landowners/managers to ensure a safe and sustainable intensive agricultural practice is employed. Government Departments such as the NSW Department of Primary Industries (NSW DPI) and the Sydney Catchment Authority (SCA) have collated or produced excellent detailed and highly practical information on best practice methodologies/current recommended practices for intensive plant agriculture land uses. These Departments also may provide access to appropriate land management professionals to assist in the planning



and implementation of best management practices. Full information on best practice methodologies or current recommended practices can be found on Government Departments / Agency websites and will not be reiterated within this DCP.

B3.3 Site Suitability for Particular Development

In assessing an application for any agricultural or ancillary use of rural land Council will give careful consideration to the appropriateness of the site for the type of activity proposed. The fact that a particular development is permissible in a zone does not automatically mean that Council will permit that development to occur.

There may be valid site-specific reasons why such development is not approved, including environmental factors, the location of the site, and the degree of accessibility from rural roads. A development proposal may be quite appropriate for one site, but not for another due to such site and access constraints.

B3.4 Types of Agriculture

The objectives and controls contained in this section of the DCP relate to the following types of development:

Aquaculture – pond-based, natural water based and tank-based.

Intensive Plant Agriculture – horticulture, turf farming, viticulture and the cultivation of irrigated crops other than farm forestry.

Intensive Livestock Agriculture – feedlots, restricted dairies, poultry farms and piggeries.

The definition of each type of land use and the zones within which each activity is permissible with consent are contained in Wingecarribee LEP 2010. Following are objectives and controls which apply to all these developments. In some cases, additional development-specific controls follow.

B3.5 Objectives

In assessing an application for any development to which this section of the DCP applies, Council will have regard for the extent to which the proposal meets the following objectives. Each application will seek to:



- (a) ensure that best practice methodologies and current recommended practices are reflected in the siting, design and proposed management of the development.
- (b) ensure that the proposed activities do not create adverse impacts on the immediate the environment.
- (c) ensure that the proposal meets all environmental targets set by Council and by the relevant State or Federal authorities.
- (d) ensure that the proposal meets all Council's requirements as described in Part A of this Plan.

B3.6 Controls

- (a) Full compliance with all sections of Part A of this Plan.
- (b) The Statement of Environmental Effects must demonstrate how best management practices / current recommended practiced etc are addressed to ensure the ecological sustainability of the development.
- (c) In preparing the Statement of Effects the following development-specific issues must be addressed:

Aquaculture	<p>Details of how waste water will be managed to ensure that there is no unacceptable runoff into natural waterways.</p> <p>Details of the location and type of upstream water sources to ensure that no contaminants enter the aquaculture water system.</p>
Intensive Plant Agriculture	<p>Details of the degree of earth disturbance the activity will require.</p> <p>Consideration of potential erosion and sedimentation issues.</p> <p>Sources of plant material and certification regarding quality.</p>
Intensive Livestock Agriculture	<p>A full analysis of all amenity issues including dust, noise, odour and visual amenity</p> <p>Details of management protocols to minimise odour impacts, considering prevailing winds, timing</p>



of cleaning, timing of effluent application etc.

- (d) The siting and placement of any buildings may need to demonstrate that they do not detract from the scenic/ landscape value of the area. For this reason such buildings may need to be clustered and screened on particular sections of the property.
- (e) A Landscape Plan, prepared by a suitably qualified landscape specialist shall be prepared indicating proposed buffer plantings to screen plant and equipment.

B3.7 Farm Stay Accommodation

B3.7.1 Introduction

Farm stay accommodation provides a valuable alternative form of tourist accommodation which both widens the tourist experience and also allows working farms to generate some additional income.

Under WLEP 2010, *farm stay accommodation means tourist and visitor accommodation provided to paying guests on a working farm as a secondary business to primary production.* WLEP 2010 permits farm stay accommodation in all zones to which this Plan applies to a maximum of three (3) bedrooms.

B3.7.2 Objectives

The controls described below are intended to achieve the following objectives:

- (a) To provide low scale tourist accommodation throughout the Shire.
- (b) To ensure that farm stay accommodation operates only as an ancillary function to the primary production functions of the property.
- (c) To ensure that farm stay accommodation is compatible with the rural amenity of the area.
- (d) To ensure that farm stay accommodation operates in accordance with relevant industry standards.
- (e) To ensure that appropriate health and fire safety standards are satisfied and maintained.



B3.7.3 Development Guidelines

- (a) When lodging a development application, the following information is to be provided:
- (i) A site analysis as described in Section A3 indicating the location of the proposed farm stay accommodation and the proposed parking facilities.
 - (ii) Details of the proposed design and construction of the farm stay accommodation facilities.
 - (iii) Appropriate access and functional requirements for people with a disability.

B3.7.4 Development Controls

To meet the above objectives and guidelines, the following controls shall apply:

- (a) All farm stay accommodation shall be located on the same lot as the principal dwelling.
- (b) Farm stay buildings shall be arranged in a cluster pattern and located to minimise any intrusion into the rural landscape.
- (c) On site car parking must be provided at the rate of 1 space per bedroom, plus 1 space per manager, plus 1 space per 2 employees.
- (d) At least one car parking space should be designed for disabled access, in accordance with current Australian Standards for the Design for Parking Facilities.
- (e) Vehicles are to enter and leave the property in a forward direction.



Section 4 Rural and Extractive Industries

B4.1 Introduction

This section of the Plan addresses objectives and controls for a range of rural and extractive industries identified in WLEP 2010. The following table defines these land uses and indicates in their permissibility within each zone to which this Plan applies.

Land Use & definition under WLEP 2010	Permissible in the RU1 zone?	Permissible in the RU2 zone?	Permissible in the E3 zone?	Permissible in the SP3 zone?
Agricultural produce industries - means an industry involving the handling, treating, processing or packing of produce from agriculture (including dairy products, seeds, fruit, vegetables or other plant material), and includes flour mills, cotton seed oil plants, cotton gins, feed mills, cheese and butter factories, and juicing or canning plants, but does not include a livestock processing industry.	Yes	Yes	No	No
Livestock processing industries - means an industry that involves the commercial production of products derived from the slaughter of animals (including poultry) or the processing of skins or wool of animals, derived principally from surrounding districts, and includes such activities as abattoirs, knackerries, tanneries, woolscours and rendering plants.	Yes	No	No	No



Land Use & definition under WLEP 2010	Permissible in the RU1 zone?	Permissible in the RU2 zone?	Permissible in the E3 zone?	Permissible in the SP3 zone?
Sawmill or log processing industries - means a building or place used for handling, cutting, chipping, pulping or otherwise processing logs, baulks, branches or stumps, principally derived from surrounding districts, into timber or other products derived from wood.	Yes	No	No	No
Stock and sale yards - means a building or place used on a commercial basis for the purpose of offering livestock or poultry for sale and may be used for the short term storage and watering of stock.	Yes	No	No	No
Extractive industry - means the winning or removal of extractive materials (otherwise than from a mine) by methods such as excavating, dredging, tunnelling or quarrying, including the storing, stockpiling or processing of extractive materials by methods such as recycling, washing, rushing, sawing or separating, but does not include turf farming.” Within that context extractive material means “sand, soil, gravel, rock or similar substances that are not minerals within the meaning of the <i>Mining Act 1992</i> .	Yes	Yes	No	No
Mining - means mining carried out	Yes	Yes	Yes	No



Land Use & definition under WLEP 2010	Permissible in the RU1 zone?	Permissible in the RU2 zone?	Permissible in the E3 zone?	Permissible in the SP3 zone?
under the <i>Mining Act 1992</i> or the recovery of minerals under the <i>Offshore Minerals Act 1999</i> , and includes: <ul style="list-style-type: none"> (a) the construction, operation and decommissioning of associated works, and (b) the rehabilitation of land affected by mining. 				

Because of the scale and unique nature of these industries, such development will be classified as designated development. Therefore, applicants must consult with Council before preparing any documents for lodgement. Council can then best advise the applicant on how to proceed. In the first instance, applicants are advised to read through Part A of this Plan, particularly the range of environmental controls, and the following sub-clauses.

B4.2 Objectives

In assessing a land use application for rural or extractive industries Council will seek to achieve the following objectives.

- (a) To ensure best practice methodologies and current recommended practices are employed by land owners / managers.
- (b) To ensure that no adverse impacts or effects occur as a result of any rural or extractive industries.
- (c) To ensure no pollutants are generated and / or released into the water catchments as a result of any rural or extractive industries.
- (d) To ensure that no rural or extractive industries pose any risk or safety threat to any residents of the Shire.
- (e) To ensure that any rural or extractive industries have mitigated any negative impacts prior to operation.



- (f) To ensure that all rural or extractive industries are subjected to regular testing and checking to ensure compliance with all relevant legislation and recommended practices

B4.3 Controls

- (a) The proposal must demonstrate compliance with all relevant sections of Part A of this Plan.
- (b) All relevant best management practices / current recommended practiced etc as nominated by all relevant authorities must be incorporated into all rural or extractive industries.
- (c) A site analysis and Environmental Impact Statement must be prepared for the land upon which the development is proposed, that address the potential impacts of the proposed rural or extractive industries. The following information must be included:
 - (i) The slope and contours of land;
 - (i) The location and nature (whether perennial or intermittent) of any watercourses wetlands and associated flooding or drainage characteristics;
 - (ii) The location of any dams and natural springs
 - (iii) The proposed method for dealing with any wastewater
 - (iv) The location, extent and nature of any existing development, buildings and activities upon, adjacent and in proximity to the land;
 - (v) The location and nature of any utility services;
 - (vi) The location of significant topography, landform features and natural structures on the site, such as escarpments, rock outcrops and water features.
 - (vii) Views to the land, particularly from a public place;
 - (viii) Directions from which climatic features affect the site, such as sun, wind, cold air drainage.
 - (ix) The location and description of any trees, groups of trees and vegetation upon, adjacent and in proximity to the land;
 - (x) Any items or places of known Aboriginal and European cultural heritage;
 - (xi) The direction and nature of prevailing climate characteristics such as wind direction and rainfall;



- (xii) Development constraints, such as steep land, slippage areas, bush fire threat, fire prone vegetation, flooding or other environmental hazards.
 - (xiii) The location and nature of any other known constraint to development of the land, including potential soil contamination, noise sources, geotechnical issues.
 - (xiv) Details of all access and egress points, vehicle parking including truck parking, safe pedestrian access, visitor access.
- (d) A Landscape Concept Plan, prepared by a person with appropriate qualifications, must accompany the Site Analysis and Assessment documents.
- (e) A written statement and drawings explaining how the design of the proposed development has taken the site analysis and Environmental Impact Statement into account.

Section 5 Tourist-related Development

B5.1 Introduction

Tourism provides a valuable economic resource for the Shire and tourism-related activities are encouraged where they may be appropriately located. WLEP 2010 identifies two areas of land zoned SP3 Tourist, as indicated in [Figures B5.1](#) and [B5.2](#) below.

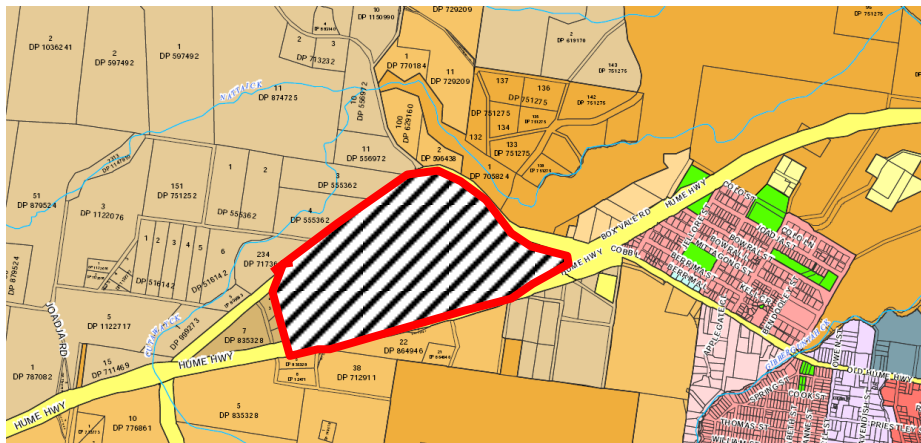

Figure B5.1 –SP3 (Tourist) land at Welby

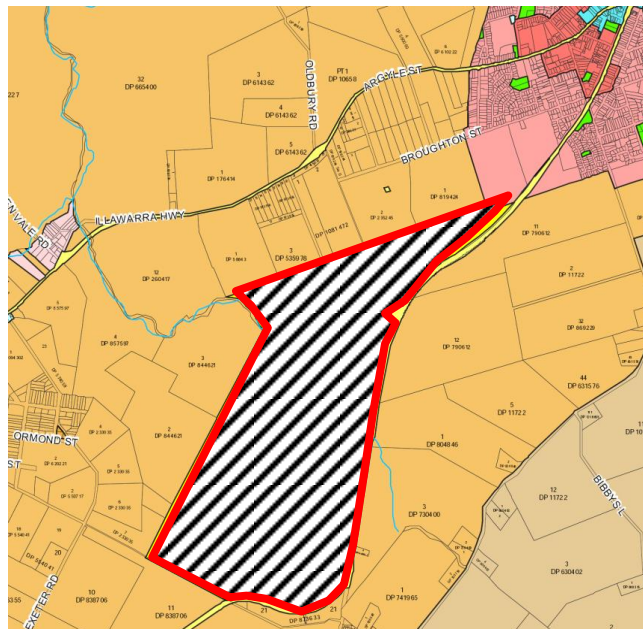

Figure B5.2 –SP3 (Tourist) land at Moss Vale



These locations occur within a rural landscape and therefore Council expects that development within these areas will comply with the overall objectives and controls for all development within this Plan.

This section of the Plan addresses those forms of tourist related development which are permissible with consent in the SP3 Tourist zone, but not in the other three zones, namely:

- Tourist and Visitor Accommodation,
- Food and Drink premises, and
- Indoor Recreation Facilities.

NB: Recreation Areas and Outdoor Recreation Facilities, which are permissible with consent in all zones to which this Plan applies, are considered in Section 6 of the Plan relating to Commercial Development.

B5.2 Tourist and Visitor Accommodation

The following objectives and controls for Tourist and Visitor Accommodation relate to those developments which are permissible with consent in the SP3 Tourist zone, but, except for camping grounds, are not permissible in the other three zones to which this Plan applies. These are:

- › Hotel or Motel accommodation
- › Serviced apartments
- › Backpackers' Accommodation
- › Caravan Parks
- › Camping Grounds.

Bed and Breakfast and Farm Stay Accommodation are also forms of tourist and visitor accommodation, but are addressed elsewhere in the Plan. Bed and Breakfast Accommodation is considered ancillary to Residential Development, so is addressed in Section B2.9. Farm Stay Accommodation is considered ancillary to Agricultural Development and so is considered in Section B3.7 of the Plan. Applicants are directed to WLEP 2010 which provides a definition for each of these land uses.

B5.2.1 Objectives

In permitting tourist and visitor accommodation in the SP3 zone, Council seeks to ensure that such development is:



- (a) Sited and designed to respect the rural environment within which the development is located.
- (b) Appropriately located to ensure no detrimental impacts on neighbouring development.
- (c) Constructed from materials which respect the rural landscape.
- (d) Complements the style of any existing development within the SP3 Tourist zone.
- (e) Designed to provide adequate car parking, located to be accessible to tourists and visitors to the development without detracting from the rural landscape in which the development is located.
- (f) Appropriately located in terms of accessibility from regional access roads.
- (g) Appropriately located in terms of the suitability of the surrounding road network to support the level and type of traffic expected to be generated by the proposed development

B5.2.2 Controls

Each development proposal will be assessed on its merits with regard to all relevant sections of this Plan as well as the above objectives.

B5.3 Food and Drink Premises

Tourist and Visitor Accommodation generally occurs in conjunction with various types of food and drink premises. Under WLEP 2010, Food and Drink Premises are defined as a form of retail premises and include takeaway food and drink premises. This sub-section also addresses proposed development for Restaurants and Cellar Door Premises as well as Kiosks.

B5.3.1 Objectives

In permitting food and drink premises in the SP3 zone, Council seeks to ensure that such development is:

- (a) Sited and designed to respect the rural environment within which the development is located.
- (b) Appropriately located to ensure no detrimental impacts on neighbouring development.
- (c) Constructed from materials which respect the rural landscape.
- (d) Complements the style of any existing development within the SP3 Tourist zone.



- (e) Designed to provide adequate car parking, located to be accessible to tourists and visitors to the development without detracting from the rural landscape in which the development is located.
- (f) Appropriately located in terms of accessibility from regional access roads.
- (g) Appropriately located in terms of the suitability of the surrounding road network to support the level and type of traffic expected to be generated by the proposed development.

B5.3.2 Controls

Each development proposal will be assessed on its merits with regard to all relevant sections of this Plan as well as the above objectives.

B5.4 Indoor Recreation Facilities

Indoor Recreation Facilities are defined under WLEP 2010 as “a building or place used predominantly for indoor recreation, whether or not operated for the purposes of gain, including a squash court, indoor swimming pool, gymnasium, table tennis centre, health studio, bowling alley, ice rink or any other building or place of a like character used for indoor recreation, but does not include an entertainment facility, a recreation facility (major) or a registered club.”

Council considers that indoor equestrian facilities are a form of Indoor Recreation Area.

B5.4.1 Objectives

In permitting indoor recreation facilities in the SP3 zone, Council seeks to ensure that such development is:

- (a) Sited and designed to respect the rural environment within which the development is located.
- (b) Appropriately located to ensure no detrimental impacts on neighbouring development.
- (c) Constructed from materials which respect the rural landscape.
- (d) Complements the style of any existing development within the SP3 Tourist zone.
- (e) Designed to provide adequate car parking, located to be accessible to users of the development without detracting from the rural landscape in which the development is located.
- (f) Appropriately located in terms of accessibility from regional access roads.
- (g) Appropriately located in terms of the suitability of the surrounding road network to support the level and type of traffic expected to be generated by the proposed development, in particular the ability of the road system to cater for tourist buses and horse transport vehicles.



B5.4.2 Controls

Each development proposal will be assessed on its merits with regard to all relevant sections of this Plan as well as the above objectives.



Section 6 Other Commercial and Community Development

A number of commercial and community related land uses are permissible within consent within some or all of the rural zones to which this DCP applies. The land uses included in this section are generally independent of other rural activities and include:

- Animal Boarding and Training Establishments – includes dog boarding and training and riding schools.
- Outdoor Recreation Facilities – includes outdoor equestrian centres.
- Recreation Areas
- Information and Education Facilities
- Landscape and Garden Supplies
- Function Centres
- Research Stations
- Community Facilities
- Places of Public Worship

Applicants are directed to WLEP 2010 to confirm permissibility and determine the legal definition of each of these land uses.

B6.1 Site Suitability for Particular Development

In assessing an application for any commercial or community use of land in a rural setting Council will give careful consideration to the appropriateness of the site for the type of activity proposed. The fact that a particular development is permissible in a zone does not automatically mean that Council will permit that development to occur on a specific site.

There may be valid site-specific reasons why such development is not approved, including environmental factors, the location of the site, surrounding land uses and the degree of accessibility from rural roads. A development proposal may be quite appropriate for one site, but not for another due to such site and access constraints.



B6.2 Objectives for all Commercial Development

In permitting commercial development in any rural setting, Council seeks to ensure that such development is:

- (a) Sited and designed to respect the rural environment within which the development is located.
- (b) Appropriately located to ensure no detrimental impacts on neighbouring development.
- (c) Constructed from materials which respect the rural landscape.
- (d) Complements the style of any existing development within the vicinity.
- (e) Designed to provide adequate car parking, located to be accessible to users of the development without detracting from the rural landscape in which the development is located.
- (f) Appropriately located in terms of accessibility from regional access roads.
- (g) Appropriately located in terms of the suitability of the surrounding road network to support the level and type of traffic expected to be generated by the proposed development.

B6.2.1 Controls

In assessing an application for commercial development within the rural landscape, Council shall ensure that all requirements and reports identified in Part A of this Plan are addressed with particular reference to the above objectives.

In addition to the above controls, additional objectives and controls follow for three specific types of commercial development - Animal Boarding and Training Establishments, Function Centres and Outdoor Recreation Facilities.

B6.3 Additional Controls for Animal Boarding and Training Establishments

B6.3.1 Introduction

Under WLEP 2010, an animal boarding or training establishment means “a building or place used for the breeding, boarding, training, keeping or caring of animals for commercial purposes (other than for the agistment of horses), and includes any associated riding school or ancillary veterinary hospital.”

Such establishments are required to comply with all the objectives and the controls of this section of the Plan, but because such establishments can also cause significant noise pollution and disruption to rural amenity, further additional controls are required. These controls particularly apply to, but are not restricted to establishments caring for dogs.



B6.3.2 Objectives

The purpose of these additional controls is to ensure that any animal boarding or training establishment achieves the following objectives:

- (a) incorporates all relevant best management practices.
- (b) Generates no adverse impact on the natural environment, particularly with regard to wastewater disposal.
- (c) Generates no adverse impact on adjoining neighbours in relation to noise, odour or traffic generation.
- (d) all potential cumulative impacts of animal boarding or training establishments are taken into consideration in assessing of any application.

B6.3.3 Controls for all Establishments

In addition to the relevant controls described in elsewhere in this Plan, the following requirements apply to any application for an Animal Boarding and Training Establishment.

- (a) Establishments shall be sited as far as practical from property boundaries, particularly to boundaries adjoining residential development.
- (b) The shape and location of the property will have a determining factor on permissibility of the Establishment. Long narrow blocks may not be able to achieve the setbacks and screening required to meet objectives relating to noise and odour impacts on surrounding properties.
- (c) Screening, setbacks, buffers and siting of any Establishment shall achieve the desired level of amenity for neighbouring properties, including, but not limited to, noise and odour.
- (d) Screening should utilise materials and/or be of a design that enables adequate ventilation around the Establishment.
- (e) Any screen planting should utilise, where possible, endemic native species. Full details of plant species and placement should be detailed in the landscape plan.
- (f) Council may require the construction of earth mounds as a form of screen and to address noise abatement.
- (g) All impacts associated with the Establishment must be addressed on site with no external impacts to neighbouring properties or water bodies.
- (h) A waste water management plan will be required to be submitted with every Animal Boarding and Training Establishment application. Attention must be paid to ensure that no pollutants are discharged off site. Appropriate treatment systems for the treatment of waste water must be designed and submitted with any application.



- (i) All cumulative impacts of Animal Boarding and Training Establishments shall be considered by Council.
- (j) All Establishments shall be constructed in accordance with current best practice standards as provided by relevant licensing and peak-body organisations.

B6.3.4 Additional Specific Controls for Dog Facilities

The biggest complaint Council receives in relation to Animal Boarding and Training Establishments relates to dogs, and of those complaints most relate to noise. Even the best behaved dogs bark and dogs in groups tend to bark more than dogs on their own. Dogs in a rural setting with low ambient noise are able to hear sounds they may not hear in an urban context which may further trigger this barking response.

- (a) Animal Boarding and Training Establishments must ensure that noise does not exceed 5dB(A) above the background noise level measured at the property boundary. Applicants are directed to Section A6.9 of the Plan in this regard.
- (b) Kennels shall be designed and constructed to the minimum standards and regulations set by Dogs NSW ("*Regulation number 14 Guidelines for the Care and Management of Keeping and Breeding Dogs*") to ensure the safety and amenity of all dogs.
- (c) In checking compliance with subclause (b) above, Council will pay particular attention to the following design features:
 - (i) All kennels shall provide adequate room for dogs to stand, sit, lie, stretch and move about.
 - (ii) At least one separate soundproof kennel shall be provided for use by whelping bitches and their pups, and sick or aggressive animals.
 - (iii) Adequate ventilation must be provided to ensure the kennel is free of dampness and noxious odours.
 - (iv) Each kennel must be provided with clean bedding raised up from the floor.
 - (v) An attached, fully fenced, exercise yard shall be provided which can be accessed directly from the kennel areas. This area must be grass covered and maintained in a clean, hygienic condition. The exercise yard is not to be used after 5pm and before 8am.
- (d) All external gates and doors shall be designed to ensure that dogs cannot escape. A double door or gate system may be required.
- (e) No dogs shall be housed or kept at an Animal Boarding and Training except in approved kennels.
- (f) Flooring must be designed and constructed to ensure ease of cleaning, including an approved gradient to a drainage inlet.



- (g) External walls shall be constructed of appropriate materials to achieve the desired level of hygiene, washability and noise control.
- (h) Internal walls dividing kennels shall be of either solid construction (which assists in noise abatement), or wire chain link.
- (i) The height of the walls shall give adequate clearance for maintenance and attention to both animals and the kennel structure itself, including cleaning and repairs.
- (j) Walls shall be finished with flush mortar joints or cement render to assist in sound attenuation.
- (k) Roof shall be constructed to assist in achieving noise control.
- (l) Roof shall be designed to ensure the catchment of water to an approved tank.
- (m) Adequate water supply shall be provided. An adequate water supply is deemed to be able to meet the needs of drinking water for dogs, cleaning and hosing of kennels at least once a week, and for washing dogs.
- (n) A hose tap is required for every 5 kennels.
- (o) The location and design of any car parking, ingress and egress shall not negatively impact on adjoining properties.
- (p) The location of any car parking must enable clear access for dogs from the car park to the kennels out of site of the dogs housed on the property.

B6.4 Function Centres

Under WLEP 2010, a Function Centre means “a building or place used for the holding of events, functions, conferences and the like, and includes convention centres, exhibition centres and reception centres, but does not include an entertainment facility.”

Function Centres are permissible with consent in the SP3 Tourist zone. To ensure that such premises operate in a manner which does not adversely affect the surrounding amenity of the area, Council shall be satisfied that the applicant has given due regard to the following key objectives:

Key Objectives

- a) To provide opportunities for function centres in appropriate locations regulated by appropriate planning controls,
- b) To promote the location as a safe place for patrons, particularly late at night,
- c) To minimise disturbances to the public and surrounding location in the late evening and early morning hours,



d) To demonstrate an ongoing commitment to the local community with regard to the operation of the function centre through the preparation and implementation of appropriate Management Plans.

Additional Controls for Function Centres

- a) Applicants seeking to develop a Function Centre are directed to Section B6.1 and 6.2 above.
- b) All Function Centres shall be assessed on their merits with particular regard to:
 - (i) visual impacts of the proposal
 - (ii) potential noise impacts
 - (iii) potential traffic generation
- c) Buildings shall be designed and located to minimise visual impacts within the rural landscape, particularly from neighbouring properties.
- d) Buildings shall be constructed from materials and colours which blend into the rural landscape.
- e) Proposed development shall not exceed 5dB(A) as required in Section A6.8 of this Plan.
- f) Lighting shall be designed to minimise impact on the night sky as required in Section A6.10 of this Plan.
- g) Particular attention will be paid to the potential traffic generation of the proposal with regard to its impact on the rural amenity, the road network and the types of vehicles likely to use the facility, including delivery and servicing vehicles.

B6.5 Outdoor Recreation Facilities

Under WLEP 2010, An Outdoor Recreation Facility means “a building or place (other than a recreation area) used predominantly for outdoor recreation, whether or not operated for the purposes of gain, including a golf course, golf driving range, mini-golf centre, tennis court, paint-ball centre, lawn bowling green, outdoor swimming pool, equestrian centre, skate board ramp, go-kart track, rifle range, water-ski centre or any other building or place of a like character used for outdoor recreation (including any ancillary buildings), but does not include an entertainment facility or a recreation facility (major).”



Outdoor Recreation Facilities are permissible with consent in all zones to which this Plan applies. Council notes that the definition does not require these facilities to be commercial in nature, however as most such facilities would most probably be commercial, they have been included in this section of the Plan.

B6.5.1 Additional Controls for Outdoor Recreation Facilities

- (a) Applicants seeking to develop an Outdoor Recreation Facility are directed back to Section B6.1 and 6.2 above.
- (b) All outdoor recreation facilities will be assessed on their merits with particular regard to:
 - (i) visual impacts of the proposal
 - (ii) potential noise impacts
 - (iii) potential traffic generation
- (c) Buildings shall be designed and located to minimise visual impacts within the rural landscape, particularly from neighbouring properties.
- (d) Buildings shall be constructed from materials and colours which blend into the rural landscape.
- (e) Proposed development shall not exceed the 5dB(A) as required in Section A6.9 of this Plan.
- (f) Particular attention will be paid to the potential traffic generation of the proposal with regard to its impact on the rural amenity, the road network and the types of vehicles likely to use the facility. For example, an equestrian centre will be assessed in terms of whether the surrounding road network can manage horse transport vehicles.

B6.5.2 Additional Controls for Equine Facilities (covered)

Where an equine facility (i.e. dressage arena) is proposed to be covered and/or enclosed, the following additional controls apply:

Development Siting and Location

- (a) Equine facilities shall make use of the existing natural topography and vegetation and be located to minimise the visual impacts when viewed from public places and adjoining properties.
- (b) Equine facilities shall not be located on features such as ridge lines, hill tops, horizons, prominent slopes and topographic features.



- (c) Equine facilities shall generally be clustered with existing buildings on the site, to minimise the visibility and bulk of the built form when viewed from public places and neighbouring properties.
- (d) Equine facilities and structures shall be set back a minimum of 50 metres from any public road, unless assessed by Council as appropriate due to site constraints.
- (e) Equine facilities and structures shall be set back a minimum of 30 metres from any side or rear boundary and shall be located a minimum of 50 metres from any dwelling on adjoining properties.

Built Form and Landscaping

- (a) A maximum of one covered or enclosed equine facility (dressage arena) is permitted on any site, and the total ground floor area shall not exceed 1,400 square metres.
- (b) The design of structures shall be in keeping with the character and design of typical rural buildings in the area.
- (c) Structures shall be constructed from non-reflective materials. Zinalume is not permissible.
- (d) Landscaping should be used to minimise the visibility and bulk of the built form when viewed from public places and neighbouring properties in accordance with Section B2.1.6.